



Core Knowledge®

HISTORY AND GEOGRAPHY

# Ancient Rome

Teacher Guide

Julius Caesar



Caesar Augustus



The Second Punic War

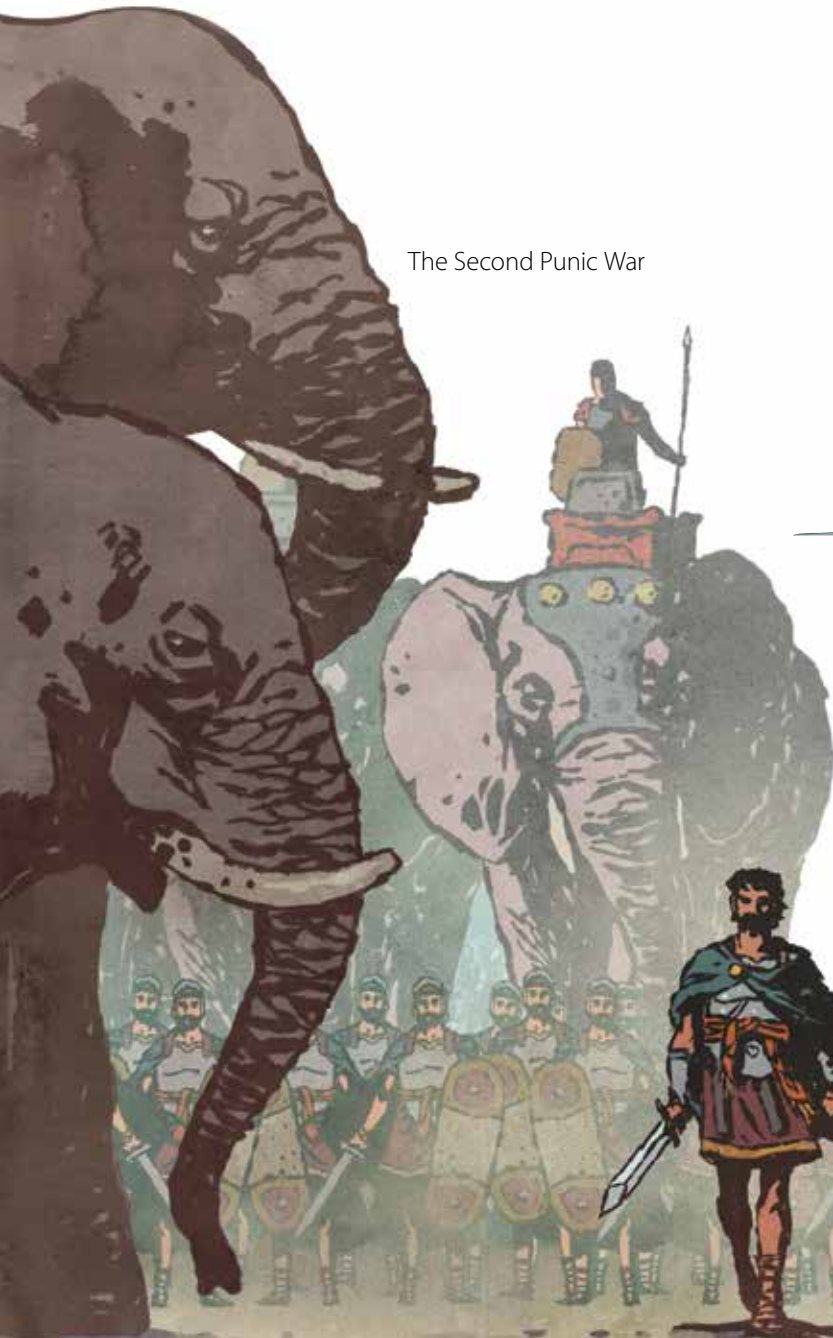

Cleopatra



# Ancient Rome

Teacher Guide

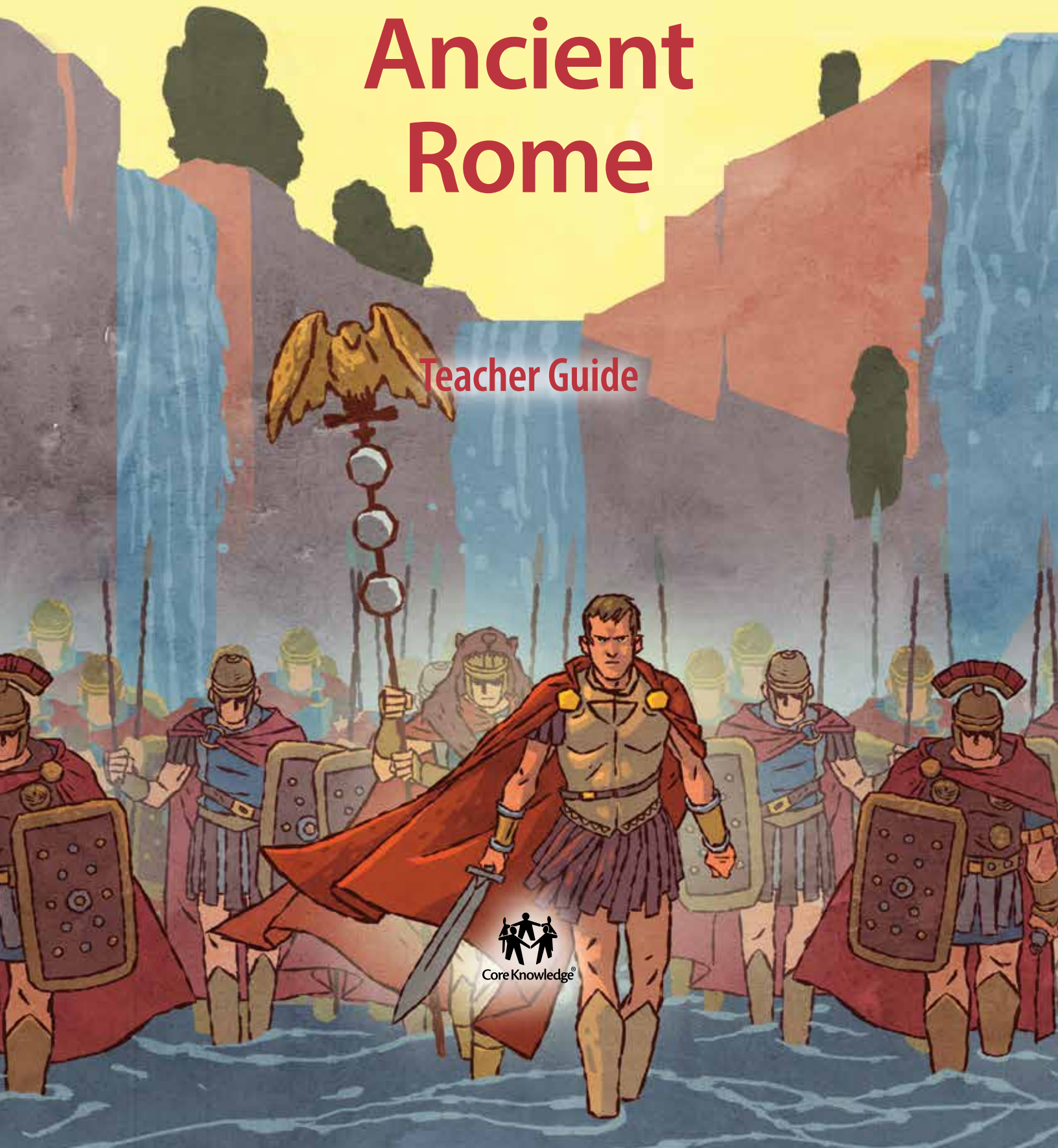

Core Knowledge®

## Creative Commons Licensing

This work is licensed under a Creative Commons Attribution-NonCommercial-ShareAlike 4.0 International License.



### You are free:

- to Share**—to copy, distribute, and transmit the work
- to Remix**—to adapt the work

### Under the following conditions:

**Attribution**—You must attribute the work in the following manner:

*This work is based on an original work of the Core Knowledge® Foundation ([www.coreknowledge.org](http://www.coreknowledge.org)) made available through licensing under a Creative Commons Attribution-NonCommercial-ShareAlike 4.0 International License. This does not in any way imply that the Core Knowledge Foundation endorses this work.*

**Noncommercial**—You may not use this work for commercial purposes.

**Share Alike**—If you alter, transform, or build upon this work, you may distribute the resulting work only under the same or similar license to this one.

### With the understanding that:

For any reuse or distribution, you must make clear to others the license terms of this work. The best way to do this is with a link to this web page:

<https://creativecommons.org/licenses/by-nc-sa/4.0/>

Copyright © 2016 Core Knowledge Foundation  
[www.coreknowledge.org](http://www.coreknowledge.org)

All Rights Reserved.

Core Knowledge®, Core Knowledge Curriculum Series™, Core Knowledge History and Geography™ and CKHG™ are trademarks of the Core Knowledge Foundation.

Trademarks and trade names are shown in this book strictly for illustrative and educational purposes and are the property of their respective owners. References herein should not be regarded as affecting the validity of said trademarks and trade names.

# Ancient Rome

## Table of Contents

Introduction .....	1
<i>Ancient Rome</i> Sample Pacing Guide .....	16
Chapter 1 <b>Romulus and Remus</b> .....	22
Chapter 2 <b>Roman Gods and Goddesses</b> .....	31
Chapter 3 <b>The Roman Republic</b> .....	38
Chapter 4 <b>The Punic Wars</b> .....	45
Chapter 5 <b>Julius Caesar</b> .....	51
Chapter 6 <b>Cleopatra, Queen of Egypt</b> .....	57
Chapter 7 <b>Julius Caesar Dies</b> .....	61
Chapter 8 <b>Caesar Augustus</b> .....	67
Chapter 9 <b>Roman Lands</b> .....	72
Chapter 10 <b>Roads, Bridges, and Aqueducts</b> .....	77
Chapter 11 <b>The Buildings of Rome</b> .....	85
Chapter 12 <b>Gladiators and Chariot Races</b> .....	93
Chapter 13 <b>Pompeii</b> .....	99
Chapter 14 <b>The Romans and the Christians</b> .....	107
Chapter 15 <b>The Decline of the Roman Empire</b> .....	112
Chapter 16 <b>East and West</b> .....	117
Teacher Resources .....	125

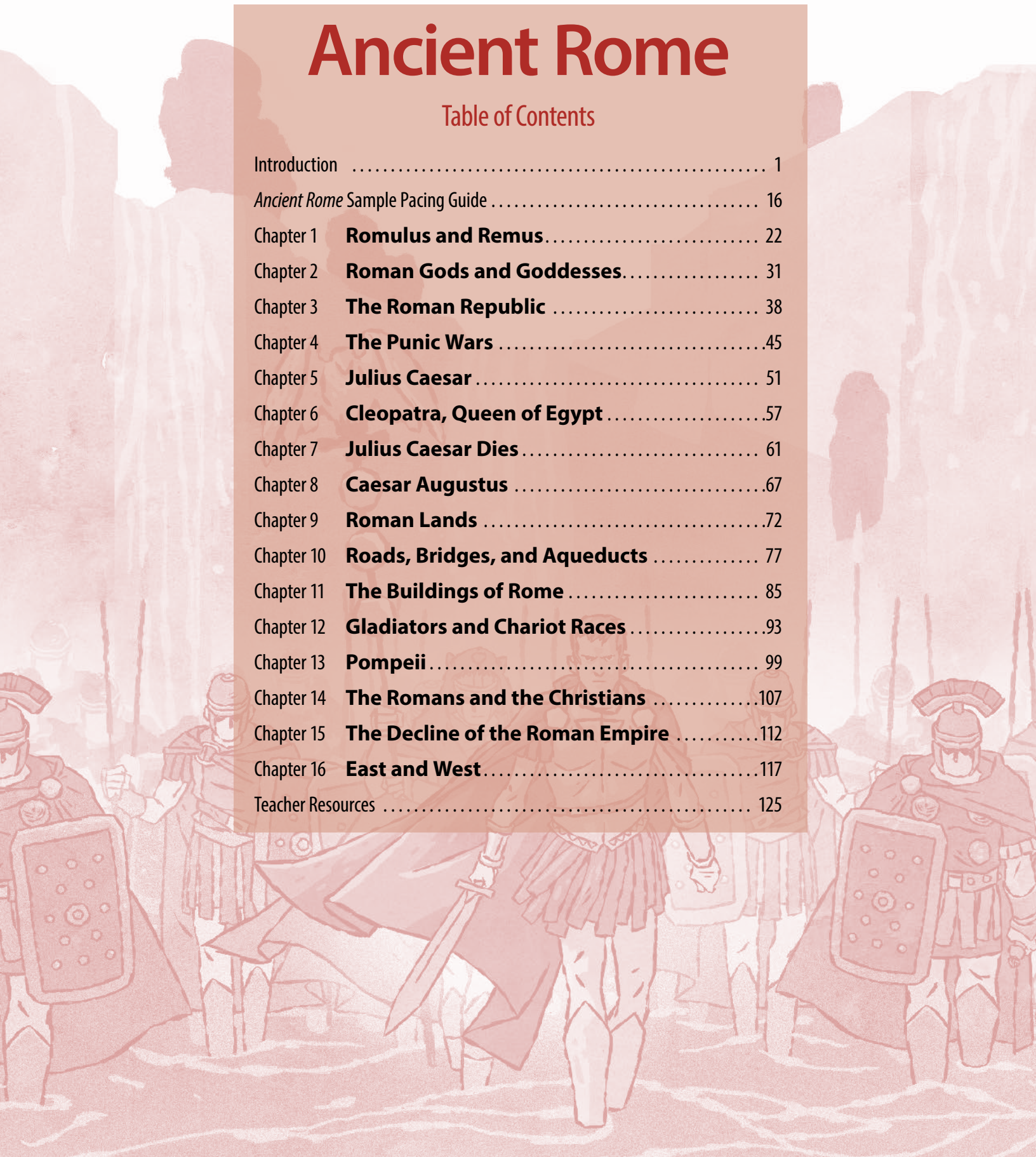

**Ancient Rome**  
**Teacher Guide**

*Core Knowledge Sequence* History and Geography 3

# Introduction

## ABOUT THIS UNIT

### The Big Idea

The city of Rome expanded from humble origins to rule much of Europe and the Mediterranean.

Rome began over 2,750 years ago as a small cluster of huts on the banks of the Tiber River, which empties into the Mediterranean Sea. The Mediterranean was an important route for trade and culture, and Rome's location near the sea helped it grow. From the beginning, Rome included people of several tribes, or ethnic groups. Over the centuries, this little society developed a government that shared power among a group of families. In the Roman Republic, the people got to choose their own representatives as their rulers.

As Rome grew, it expanded its territory. The three Punic Wars (264–241 BCE, 218–202 BCE, 149–146 BCE) between Rome and Carthage allowed Rome to gain control of key lands elsewhere on the Mediterranean, in North Africa. Placing a high value on military strength and borrowing ideas from other cultures, Rome gained more territory until it became a mighty empire controlling nearly all the land surrounding the Mediterranean Sea. Throughout the empire, the Romans spread the Latin language, styles of architecture, and codes of law. Roman-built infrastructure, including bridges, aqueducts, and more than fifty thousand miles of roads, eventually allowed Judeo-Christian monotheism to spread.

Over time, however, the Roman Empire declined. To address mounting problems, the Romans divided their empire in the late 200s, first into administrative zones, then into Eastern and Western Empires. The Eastern Empire flourished, effectively unifying the Roman Empire throughout the fourth and early fifth centuries. The Western Empire collapsed in 476 CE. Despite the fall of Rome, Roman political ideas, philosophy, and literature have strongly influenced the development of Europe and other areas of the world.

# What Students Should Already Know

Students in Core Knowledge schools should be familiar with:

- Mediterranean Sea, Aegean Sea
- Worship of Greek deities

# What Students Need to Learn

- Geography of the Mediterranean region
  - Mediterranean Sea, Aegean Sea, and Adriatic Sea
  - Greece, Italy (peninsula), France, Spain
  - Strait of Gibraltar, Atlantic Ocean
  - North Africa, Asia Minor (peninsula), Turkey
  - Bosphorus (strait), Black Sea, Istanbul (Constantinople)
  - Red Sea, Persian Gulf, Indian Ocean
- Background of the founding and growth of Rome
  - The definitions of BC and AD and of BCE and CE
  - The legend of Romulus and Remus
  - Latin as the language of Rome
  - The worship of deities based on Greek religion
  - The republic: Senate, patricians, plebeians
  - The Punic Wars: Carthage, Hannibal
- The Roman Empire
  - Julius Caesar (defeats Pompey and becomes dictator; “*Veni, vidi, vici*”—“I came, I saw, I conquered”; associated with Cleopatra of Egypt; assassinated in the Senate by Brutus)
  - Caesar Augustus
  - Life in the Roman Empire (the Forum; the Colosseum; roads, bridges, and aqueducts)
  - The eruption of Mount Vesuvius and the destruction of Pompeii
  - The persecution of Christians
- The decline and fall of Rome, including corrupt emperors, civil wars, and the sacking of Rome by the Visigoths in 410 CE
- Constantinople merges diverse influences and cultures as the seat of the empire

## Time Period Background

This timeline provides an overview of key events. Use a classroom timeline with students to help them sequence and relate events that occurred over hundreds of years.

<b>753 BCE</b>	Traditional date for founding of Rome
<b>509 BCE</b>	Founding of the Roman Republic
<b>264–146 BCE</b>	Three Punic Wars with Carthage
<b>59 BCE</b>	Julius Caesar made consul
<b>58–51 BCE</b>	Gallic Wars between Rome and Gaul
<b>44 BCE</b>	Julius Caesar assassinated on the Ides of March
<b>31 BCE</b>	Battle of Actium (defeat of Antony and Cleopatra)
<b>27 BCE–14 CE</b>	Caesar Augustus the sole ruler of Roman Empire; end of the Roman Republic
<b>64 CE</b>	Nero blames fire in Rome on Christians
<b>79 CE</b>	Eruption of Mount Vesuvius buries Pompeii
<b>284–305 CE</b>	Rule of Emperor Diocletian and period of severe persecution of Christians
<b>313 CE</b>	Edict of Milan allows Christians to practice their religion
<b>324 CE</b>	Constantinople built on the site of Byzantium, named capital by Constantine
<b>476 CE</b>	Fall of Western Empire to Germanic invaders



## AT A GLANCE

The most important ideas in Unit 2 are:

- Students should be able to locate major geographical features of the Mediterranean and major sections of the Roman Empire.
- The Romans created a legend (Romulus and Remus) to explain the city's founding.
- The Romans adopted and adapted Greek mythology and deities to their own culture.
- The Roman Republic evolved from one dominated by patricians to one in which plebeians also had power.
- The Romans not only defeated but destroyed Carthage in the Punic Wars.
- Julius Caesar was ambitious but also attempted to reform the government of the Roman state.
- The reign of Caesar Augustus ushered in the two-hundred-year *Pax Romana* and marked the end of the republic and the beginning of the Roman Empire.
- The Roman Empire ended for a variety of reasons: military, economic, political, and social.
- The Eastern Roman Empire lasted until 1453 as the Byzantine Empire.
- Roman political ideas, institutions, and works of literature (written in Latin) have had a tremendous impact on European history and culture.

## WHAT TEACHERS NEED TO KNOW

### Geography of the Mediterranean Region

---

You may find it helpful to refer to the activity page maps AP 1.1 and AP 1.3 on pages 137 and 139 while reading this section.

#### Water

##### Mediterranean, Aegean, and Adriatic Seas

The Mediterranean is the world's largest inland sea. It takes its name from Latin and means "middle of the land." It refers to the sea's position between Europe, North Africa, and the Middle East as well as to its central place in the life of the early Romans.

For centuries, the Mediterranean served as a major route for commerce and cultural diffusion among Europe, North Africa, the Middle East, and

elsewhere in Asia. In the 1300s *CE* with the rise of the Ottoman Turks and in the late 1400s *CE* with the opening of the sea route around Africa to Asia, the Mediterranean became less important. The construction of the Suez Canal, connecting the Indian Ocean and the Mediterranean, revived some of the commerce between Asia and the Mediterranean countries.

The Aegean and the Adriatic Seas are arms of the Mediterranean. The Aegean separates modern-day Greece from Turkey. South of the Aegean, between Southeastern Italy and Western Greece, the Mediterranean is called the Ionian Sea. The area is dotted with islands, most of them settled by Greeks. The Aegean area was the site of early Greek civilization.

The Adriatic Sea separates Italy from the Balkan Peninsula (modern-day Slovenia, Croatia, Bosnia and Herzegovina, Serbia and Montenegro, and Albania). The Italian and Balkan coasts of the Adriatic are very different. The Italian coast has a few tiny islands and generally has shallow water. The historic port city of Venice, on Italy's northeastern coast, is marshy with many lagoons. There are also many lagoons in the Italian Po River area. The Balkan coast, on the other hand, has many islands, and the water can be deep, particularly in some parts of Slovenia and Croatia.

### **Strait of Gibraltar and the Atlantic Ocean**

The Strait of Gibraltar is a natural waterway that lies at the western end of the Mediterranean Sea and links it to the Atlantic Ocean. The strait is only 8.5 miles wide and has been of great strategic importance throughout history.

The European area that juts out into the Mediterranean at this point is the British Crown Colony of Gibraltar. Approximately two miles square, the colony sits at the tip of Spain. Across from it is the North African nation of Morocco.

### **Bosporus and the Black Sea**

Another important strategic passageway is the water link to the Black Sea at the eastern end of the Mediterranean. From west to east, the Aegean is linked by the Dardanelles to the Sea of Marmara and then to the Bosporus, which opens into the Black Sea. The Dardanelles and the Bosporus are both straits. The Black Sea lies between Asia and Europe. Like the Mediterranean, the Black Sea is an inland sea and was an important waterway in ancient commerce. Today, the Rhine–Main–Danube Canal links the Black Sea to the North Sea. Pollution has become a problem for the Black Sea.

### **Red Sea, Persian Gulf, and Indian Ocean**

Beginning in 1859, a French company dug the Suez Canal through a narrow strip of Egypt between the Mediterranean and the Red Sea. Opened in 1869, the canal enabled ship traffic to travel from the Mediterranean through the Red Sea into the Persian Gulf and from there into the Indian Ocean. This new route cut four thousand miles off the old trip from Western Europe to India, which required sailing around the southern tip of Africa.

### Greece

Greece is the most easterly of the four large European countries around the Mediterranean. The majority of Greece is situated on the Balkan Peninsula, which juts out into the Mediterranean Sea. Approximately one-fifth of Greece is made up of islands. Crete, which marks the southern end of the Aegean Sea, is the largest Greek island. About seventy-five percent of Greece—mainland and islands—is mountainous.

The terrain greatly affected how ancient Greece developed. Greece has no flooding rivers like the Nile, Tigris, and Euphrates. Neither does it have fertile valleys or broad plains to farm. An area known as the Peloponnesus, on the mainland's southern tip, has some fertile lowlands, while some of the larger islands have small fertile valleys. Some Greeks did indeed farm for a living, while others took to the sea to find their livelihood. However, the location of Greece in the Mediterranean, Aegean, and Ionian Seas also led to the development of a large and profitable trading network for the Greeks.

### Italy

Italy lies on a peninsula that juts into the Mediterranean. A number of islands, the largest of which are Sicily and Sardinia, are also part of this country today. The Italian peninsula is shaped like a boot. A section of the Alps Mountains arcs across the north, while the Apennine Mountains run along the center of the peninsula like a spine. In the north, a broad fertile plain lies between these two mountain chains. The Po River flows across the plain and empties into the Adriatic Sea to the east. To the west of the Apennines is a broad coastal plain. Rome was built in this area along the Tiber River.

Italy was easier to unite than Greece because the Apennine Mountains have a lower elevation than the mountains in Greece. They also run north and south along the boot and do not break the peninsula up into isolated valleys. The fertile coastal plain provided a geographic and economic base for the Romans as they moved out to seize control of the peninsula and the territory beyond it.

### France and Spain

To the west of Italy are the lands of present-day France and Spain, two areas conquered by the Romans. More than half of France's terrain is lowlands. The remainder consists of hills, plateaus, and mountains, the latter making up less than one-quarter of the terrain. Spain, in contrast, is primarily a plateau about 2,300 feet above sea level. The coastal areas have a Mediterranean climate. Spain's southern coast has the highest temperatures in Europe during the winter months.

### North Africa, Asia Minor and Turkey, and Istanbul

The modern-day countries of North Africa are Egypt, Libya, Tunisia, Algeria, and Morocco. The ancient city of Carthage, which was founded by Phoenician

traders and which fought the Roman Republic in the three Punic Wars, was located in what is known today as Tunisia.

The Romans ruled vast parts of the area, and it was during Roman times that camels were introduced into North Africa from Central Asia. The use of camels enabled North Africans to traverse the Sahara and eventually build a trading network that linked West African kingdoms to Europe and Asia.

Asia Minor is a peninsula in Southwest Asia that forms most of the modern country of Turkey. Turkey is divided geographically between Europe and Asia, and the Asian portion is on this peninsula. The ancient city of Troy, described in Homer's epic poems the *Iliad* and the *Odyssey*, was situated along the coast of Asia Minor. The Romans were among the ancient peoples who conquered Asia Minor.

When the Roman Empire in the west ended, Asia Minor became the seat of the Byzantine Empire. In the 1400s CE, the Ottoman Turks seized the area and made it the base of their own vast empire. Although the size and power of the Ottoman Empire eroded over time, it continued to exist until after World War I, when the modern state of Turkey was founded in 1923.

Modern Istanbul is the largest city in Turkey and sits astride the Bosphorus in both European and Asian Turkey. The original city on this site was Byzantium, a Greek colony. In 324 CE, the Roman Emperor Constantine renamed Byzantium "Constantinople." This city became the capital of the eastern half of the Roman Empire, a region that later became the Byzantine Empire. The Ottoman Turks seized the city in 1453 CE and made it the capital of their empire. After the establishment of modern Turkey, the capital moved to Ankara, and Constantinople was renamed Istanbul in 1930.

## Historical Background

---

### Before Ancient Rome: The Ancient Greeks

Rome would one day dominate the Mediterranean world. But it was not the first great civilization to control this region. Ancient Greece came before Rome.

Greece is located on the Balkan Peninsula. It protrudes into the Mediterranean Sea, with the Aegean Sea to its west and the Ionian Sea to its east.

These seas dominated the development of Greece. Though early ancient Greeks did farm, others took to the sea. In time, the Greeks developed extensive and profitable trading networks. They also established colonies along the coasts of the Aegean, Ionian, Black, and Mediterranean Seas. Included were Greek colonies on the Italian Peninsula and the island of Sicily.

Greece lacked great rivers that supported the development of vast empires such as those that emerged in Mesopotamia and Egypt. Greece instead developed into a number of small, somewhat isolated city-states. Among these city-states there was often great competition and rivalry—and war.

One of these city states was Athens, which was first settled around 3,000 BCE. Located on the eastern side of the Greek mainland, Athens developed over time a novel form of government in which citizens held the power and made the decisions—a democracy.

Athenian culture also developed many highly advanced features. Athenian writers and philosophers, such as Socrates, Plato, and Aristotle, are celebrated even today as among the most influential in human history. The Olympic Games were also a creation of the ancient Greeks.

Greek religion would also prove highly influential on later cultures. The ancient Greeks believed in a family of gods, the twelve most powerful of whom lived on Mount Olympus. Many great buildings were raised as temples and monuments to these gods.

For background information, download the CKHG Online Resource “About Ancient Rome”:

[www.coreknowledge.org/ckhg-online-resources](http://www.coreknowledge.org/ckhg-online-resources)

## UNIT RESOURCES

### Student Component

---

The *Ancient Rome* Student Reader—Sixteen chapters

### Teacher Components

---

*Ancient Rome* Teacher Guide—Sixteen chapters. This includes lessons aligned to each chapter of the *Ancient Rome* Student Reader with a daily Check For Understanding and Additional Activities, such as virtual field trips and cross-curricular art and music activities, designed to reinforce the chapter content. A Unit Assessment, Performance Task Assessment and Activity Pages are included at the end of this Teacher Guide in Teacher Resources, beginning on page 125.

[www.coreknowledge.org/ckhg-online-resources](http://www.coreknowledge.org/ckhg-online-resources)

- » The Unit Assessment tests knowledge of the entire unit, using standard testing formats.
- » The Performance Task Assessment requires students to apply and share the knowledge learned during the unit through a written essay.
- » The Activity Pages are designed to reinforce and extend content taught in specific chapters throughout the unit. These optional activities are intended to provide choices for teachers.

**Optional:** Core Knowledge Curriculum Series™ Art Resource Packet for Grade 3—art resources that may be used with cross-curricular art activities described in the Additional Activities of Chapters 10, 11, and 16, if classroom internet access is not available. These Art Resources include images of *Le Pont du Gare Aqueduct*, the Pantheon, and the Hagia Sophia. You can purchase the Grade 3 art resource packet, available at:

[www.coreknowledge.org/store](http://www.coreknowledge.org/store)

*Ancient Rome Timeline Image Cards* include thirteen individual images depicting significant events and individuals during the time of ancient Rome. In addition to an image, each card contains a caption, a chapter number, and the Big Question, which outlines the focus of the chapter. You will construct a classroom Timeline with students over the course of the entire unit. The Teacher Guide will prompt you, lesson by lesson, as to which image card(s) to add to the Timeline. The Timeline will be a powerful learning tool enabling you and your students to track important themes and events as they occurred within this time period.

## Timeline

Some advance preparation will be necessary prior to starting Unit 2. You will need to identify available wall space in your classroom of approximately fifteen feet on which you can post the Timeline Image Cards over the course of the unit. The Timeline may be oriented either vertically or horizontally, even wrapping around corners and multiple walls, whatever works best in your classroom setting. Be creative!

Create five time indicators or reference points for the Timeline. Write each of the following on sentence strips or large index cards:

- **800–501 BCE**
- **300–101 BCE**
- **100 BCE–99 CE**
- **300–399 CE**
- **400–499 CE**

Affix these time indicators to your wall space, allowing sufficient space between them to accommodate the actual number of image cards that you will be adding to each time period as per the following diagram:

	800–501 BCE	300–101 BCE	100 BCE–99 CE	300–399 CE	400–499 CE
	••	•	•••••••	••	•
<b>Chapter</b>	<b>1</b>	<b>4</b>	<b>5, 7, 8, 13, 14</b>	<b>16</b>	<b>16</b>

Please note that there are seven timeline cards that will be inserted within the 100 BCE–99 CE time period.

You will want to post all the time indicators on the wall at the outset before you place any image cards on the Timeline.

753 BCE



Chapter 1

509 BCE



Chapter 1

264–146 BCE



Chapter 4

59 BCE



Chapter 5

58–81 BCE



Chapter 5

44 BCE



Chapter 7

31 BCE



Chapter 7

27 BCE–14 CE



Chapter 8

64 CE



Chapter 14

79 CE



Chapter 13

313 CE



Chapter 16

324 CE



Chapter 16

476 CE



Chapter 16

### The Timeline in Relation to the Content in the Student Reader Chapters

The first thing you will notice is that the events highlighted in the Unit 2 Timeline do not necessarily cover all of the chapters. The unit begins with a focus on history and historical figures, but Chapters 9 through 12 delve into the geography, infrastructure, and culture of ancient Rome. With Chapter 13, the unit returns to historical events and continues chronologically through the end of the Roman Empire. The unit as a whole covers broad themes of empire building and decline over hundreds of years.

## Understanding References to Time in the *Ancient Rome* Unit

As you read the text, you will see that the founding of Rome is legendary in nature and that therefore its date is legendary as well. Explain this to students, but emphasize that most of the chapters refer to historically precise dates. In addition, when citing specific dates, the abbreviations *BCE* and *CE* are used. It's important that students understand that the abbreviation *BCE* means "before the common era," while *CE* is used to denote common era. Students may have encountered *BCE* or *CE* before, or they may be more familiar with the traditional abbreviations *AD* and *BC*. *AD* stands for *Anno Domini* (year of our Lord), and *BC* means "before Christ." Both *CE* and *AD* refer to the time period from the birth of Jesus Christ. *BCE* and *BC* refer to the time period before Christ's birth.

## Time to Talk About Time

Before you use the Timeline, discuss with students the concept of time and how it is recorded. Here are several discussion points that you might use to promote discussion. This discussion will allow students to explore the concept of time.

1. What is time?
2. How do we measure time?
3. How do we record time?
4. How does nature show the passing of time? (Encourage students to think about days, months, and seasons.)
5. What is a specific date?
6. What is a time period?
7. What is the difference between a specific date and a time period?
8. What do *BCE* and *CE* mean?
9. What is a timeline?

## USING THE TEACHER GUIDE

### Pacing Guide

---

The *Ancient Rome* unit is one of seven history and geography units in the Grade 3 Core Knowledge Curriculum Series™. A total of thirty-five days have been allocated to the *Ancient Rome* unit. We recommend that you do not exceed this number of instructional days to ensure that you have sufficient instructional time to complete all Grade 3 units.

At the end of this Introduction, you will find a Sample Pacing Guide that provides guidance as to how you might select and use the various resources in



this unit during the allotted time. However, there are many options and ways that you may choose to individualize this unit for your students, based on their interests and needs. So, we have also provided you with a blank Pacing Guide that you may use to reflect the activity choices and pacing for your class. If you plan to create a customized pacing guide for your class, we strongly recommend that you preview this entire unit and create your pacing guide before teaching the first chapter.

## Reading Aloud

---

In each chapter, the teacher or a student volunteer will read various sections of the text aloud. When you or a student reads aloud, always prompt students to follow along. By following along in this way, students become more focused on the text and may acquire a greater understanding of the content.

## Turn and Talk

---

In the Guided Reading Supports section of each chapter, provide students with opportunities to discuss the questions in pairs or in groups. Discussion opportunities will allow students to more fully engage with the content and will “bring to life” the themes or topics being discussed.

## Big Questions

---

At the beginning of each Teacher Guide chapter, you will find a Big Question, also found at the beginning of each Student Reader chapter. The Big Questions are provided to help establish the bigger concepts and to provide a general overview of the chapter. The Big Questions, by chapter, are:

Chapter	Big Questions
1	According to legend, how did the city of Rome begin?
2	What does this story tell you about the importance of gods in the lives of Romans?
3	In ancient Rome, what was the difference between patricians and plebeians?
4	What bold attack did Hannibal make in the Second Punic War?
5	Why did some Romans think Julius Caesar was a hero?
6	What did Julius Caesar do in order to protect Cleopatra?
7	What were the reasons behind the actions taken against Julius Caesar and Marc Antony?
8	What were some of Caesar Augustus’s many accomplishments?
9	How did the Mediterranean Sea and Roman roads help the Romans manage their empire?

10	How did Roman engineering skills help the Roman Empire become so successful?
11	How was Rome similar to a modern city?
12	How were the Colosseum and the Circus Maximus similar, and how were they different?
13	What do the ruins of Pompeii tell us about life in ancient Rome?
14	Why was Christianity considered to be dangerous to Rome?
15	What did Diocletian do to help prevent the total collapse of the Roman Empire?
16	Why did the Western Empire collapse but the Eastern Empire survive for much longer?

## Core Vocabulary

Domain-specific vocabulary, phrases, and idioms highlighted in each chapter of the Student Reader are listed at the beginning of each Teacher Guide chapter, in the order in which they appear in the Student Reader. Student Reader page numbers are also provided. The vocabulary words, phrases, and idioms, by chapter, are:

Chapter	Vocabulary
1	capital, legend, king, representative
2	god, goddess, holy, temple, sacred, symbol, ember, charcoal
3	chariot, patrician, senator, citizen, plebeian, republic, assembly, Senate, consul, dictator, Forum
4	conquer, peninsula, nation, formation, barrier
5	province, governor, tax, border, civil war
6	barge, descendant
7	assassinate, toga, empire, foreigner, supplies, noble
8	aqueduct, "religious ceremony," patron, emperor
9	continent, mountain range, strait, kingdom
10	scroll, gravel, surface, valley, pillar, stake, arch
11	gladiator, marble
12	Colosseum, arena, chamber
13	ruin, pollution, preserve, volcano, Earth's crust, debris, archaeologist, trade, mosaic, amphitheater
14	persecute, "religious belief"
15	assignment, decline, corrupt, pillage, collapse
16	practice, sack

## Activity Pages

---

### Activity Pages



The following activity pages can be found in Teacher Resources, pages 137–167. They are to be used with the chapter specified. Be sure to make sufficient copies for your students prior to conducting the activities.

- Chapter 1—World Map (AP 1.1)
- Chapter 1—World Geography (AP 1.2)
- Chapter 1—Map of the Mediterranean Region (AP 1.3)
- Chapter 1—Geography of the Mediterranean Region (AP 1.4)
- Chapter 1—The Legend of Romulus and Remus (AP 1.5)
- Chapter 2—The Solar System (AP 2.1)
- Chapter 3—The Roman Republic (AP 3.1)
- Chapter 3—Life in Rome (AP 3.2)
- Chapter 4—Domain Vocabulary: Chapters 1–4 (AP 4.1)
- Chapter 6—Cleopatra’s Egypt (AP 6.1)
- Chapter 7—Antony and Octavian (AP 7.1)
- Chapter 7—Domain Vocabulary: Chapters 5–7 (AP 7.2)
- Chapter 8—Comparing Sources About Augustus (AP 8.1)
- Chapter 9—Geography of the Roman Empire (AP 9.1)
- Chapter 9—Then and Now (AP 9.2)
- Chapter 10—Roads and Bridges (AP 10.1)
- Chapter 11—The Pantheon (AP 11.1)
- Chapter 11—Domain Vocabulary: Chapters 8–11 (AP 11.2)
- Chapter 12—Androcles and the Lion (AP 12.1)
- Chapter 14—Domain Vocabulary: Chapters 12–14 (AP 14.1)
- Chapters 1–16—Domain Vocabulary: Chapters 15–16 (AP 16.1)

## Fiction and Nonfiction Excerpts

---

Use this link to download the CKHG Online Resources for this unit, where the specific links for the fiction and nonfiction excerpts may be found. They may be used with the chapter specified either for additional class work or at the end of the unit as review and/or a culminating activity. Be sure to make sufficient copies for your students prior to conducting the activities.

[www.coreknowledge.org/ckhg-online-resources](http://www.coreknowledge.org/ckhg-online-resources)

## Fiction Excerpts

Chapter 12—Androcles and the Lion (FE 1)

## Nonfiction Excerpts

Chapter 13—Primary Source Document: From Pliny the Younger’s *Letters to Tacitus* (NFE 1)

Chapter 16—Primary Source Document: The Justinian Code (Abridged) (NFE 2)

## Additional Activities and Website Links

---

An Additional Activities section, related to material in the Student Reader, may be found at the end of each chapter in this Teacher Guide. You may choose from among the varied activities when conducting lessons. Many of the activities include website links, and you should check the links prior to using them in class.

## CROSS-CURRICULAR CONNECTIONS

### Language Arts

#### Fiction

#### Myths and Mythical Characters

- More Myths and Legends of Ancient Greece and Rome (especially “Androcles and the Lion” (FE 1 and AP 12.1) and “Horatius at the Bridge”)

### Visual Arts

#### Art of Ancient Rome and the Byzantine Civilization

- Become familiar with:
  - Le Pont du Gard (Chapter 10)
  - The Pantheon (Chapter 11)
  - Byzantine Mosaics (Chapter 16)
  - Hagia Sophia (Chapter 16)

## BOOKS

Galford, Ellen. *Julius Caesar: The Boy Who Conquered an Empire*. Washington, D.C.: National Geographic, 2007.

Gedacht, Daniel. *Art and Religion in Ancient Rome*. New York: The Rosen Publishing Group, 2004.

Henty, G.A. *The Young Carthaginian*. Overland Park, KS: Digireads Publishing, 2012.

James, Simon. *DK Eyewitness Books: Ancient Rome*. New York: DK Children, 2015.

Kramer, Barbara. *National Geographic Readers: Cleopatra*. Washington, D.C.: National Geographic Children’s Books, 2015.

Macauley, David. *City: A Story of Roman Planning and Construction*. Boston: HMH Books for Young Readers, 1983.

Mitton, Janet. *The Planet Gods: Myths & Facts About the Solar System*. Illus. Christina Ballit. Washington, DC: National Geographic, 2008.

Osborne, Mary Pope. *Pompeii: Lost & Found*. Illus. Bonnie Christensen. New York: Alfred A. Knopf., 2006.

Osborne, Mary Pope. *Vacation Under the Volcano* (Magic Tree House, No. 13). Illus. Sal Murdocca. New York, Random House, 1998.

Phillips, Robin. *Who in the World was The Acrobatic Empress?: The Story of Theodora* (Who in the World Series) Illus. Jeff West. Charles City, VA: The Well-Trained Mind Press, 2006.

Scollan, Margaret. *The Gods of Rome: Dei Romae*. Bloomington, IN: Trafford Publishing, 2009.

Van Vleet, Carmella. *Explore Ancient Rome!* (Explore Your World Series). Illus. Alex Kim. White River Junction, VT: Nomad Press, 2008.

Weiss, Jim. *Julius Caesar and the Story of Rome*. Charles City, VA: The Well-Trained Mind Press. Audio recording.

Use this link to download the CKHG Online Resources for this unit, where the specific link to purchase the Jim Weiss audio recordings may be found:

[www.coreknowledge.org/ckhg-online-resources](http://www.coreknowledge.org/ckhg-online-resources)

- Julius Caesar and the Story of Rome

*Why Why Why Did Romans Race to the Circus?* (Why? Why? Why? Series) Broomhall, PA: Mason Crest Publishers, 2009.

# ANCIENT ROME SAMPLE PACING GUIDE

For schools using the *Core Knowledge® Sequence* and/or CKLA

TG–Teacher Guide; SR–Student Reader; AP–Activity Page; FE–Fiction Excerpt

## Week 1

### Day 1

### Day 2

### Day 3

### Day 4

### Day 5

#### Ancient Rome

"World Geography" (TG, Chapter 1, Additional Activities, AP 1.1 and 1.2)	"Geography of the Mediterranean Region" (TG, Chapter 1, Additional Activities, AP 1.3 and 1.4)	"Romulus and Remus" Core Lesson (TG & SR, Chapter 1)	"BCE and CE" (TG, Chapter 1, Additional Activities)	"Roman Gods and Goddesses" Core Lesson (TG & SR, Chapter 2)
---	---	--	--	---

#### CKLA

"Classification of Animals"	"Classification of Animals"	"Classification of Animals"	"Classification of Animals"	"Classification of Animals"
-----------------------------	-----------------------------	-----------------------------	-----------------------------	-----------------------------

## Week 2

### Day 6

### Day 7

### Day 8

### Day 9

### Day 10

#### Ancient Rome

"The Solar System" (TG, Chapter 2, Additional Activities, AP 2.1)	"The Roman Republic" Core Lesson (TG & SR, Chapter 3)	"City Life During the Roman Republic" (TG, Chapter 3, Additional Activities, AP 3.2)	"The Punic Wars" Core Lesson (TG & SR, Chapter 4)  Homework: Domain Vocabulary: Chapters 1–4 (AP 4.1)	"The Punic Wars" (TG, Chapter 4, Additional Activities)
--	---	---	---	---

#### CKLA

"The Human Body"	"The Human Body"	"The Human Body"	"The Human Body"	"The Human Body"
------------------	------------------	------------------	------------------	------------------

## Week 3

### Day 11

### Day 12

### Day 13

### Day 14

### Day 15

#### Ancient Rome

"Julius Caesar" Core Lesson (TG & SR, Chapter 5)	"Cleopatra, Queen of Egypt" Core Lesson (TG & SR, Chapter 6)	"Cleopatra's Egypt" (TG, Chapter 6, Additional Activities, AP 1.1, 1.3, and 6.1)	"Julius Caesar Dies" Core Lesson (TG & SR, Chapter 7) Homework: Domain Vocabulary: Chapters 5–7 (AP 7.2)	"Caesar Augustus" Core Lesson (TG & SR, Chapter 8)
--	--	---	---	--

#### CKLA

"The Human Body"	"The Human Body"	"The Human Body"	"The Human Body"	"The Human Body"
------------------	------------------	------------------	------------------	------------------

# ANCIENT ROME SAMPLE PACING GUIDE

For schools using the *Core Knowledge Sequence* and/or CKLA

TG–Teacher Guide; SR–Student Reader; AP–Activity Page; FE–Fiction Excerpt

## Week 4

**Day 16**

**Day 17**

**Day 18**

**Day 19**

**Day 20**

### Ancient Rome

“Comparing Sources About Augustus” (TG, Chapter 8, Additional Activities), AP 8.1	“Roman Lands” Core Lesson (TG & SR, Chapter 9)	“Geography of the Roman Empire” (TG, Chapter 9, Additional Activities, AP 9.1)	“Then and Now” (TG, Chapter 9, Additional Activities, AP 9.2)	“Roads, Bridges, and Aqueducts” Core Lesson (TG & SR, Chapter 10)
---	--	--	---	---

### CKLA

“The Human Body”	“The Human Body”	“The Human Body”	“The Human Body”	“The Human Body”
------------------	------------------	------------------	------------------	------------------

## Week 5

**Day 21**

**Day 22**

**Day 23**

**Day 24**

**Day 25**

### Ancient Rome

“Pont du Gard” (TG, Chapter 10, Additional Activities)	“The Buildings of Rome” Core Lesson (TG & SR, Chapter 11)  Homework: Domain Vocabulary: Chapters 8–11 (AP 11.2)	“The Pantheon” (TG, Chapter 11, Additional Activities)	“Gladiators and Chariot Races” Core Lesson (TG & SR, Chapter 12)	“The Colosseum” (TG, Chapter 12, Additional Activities)
--	---	--	--	---

### CKLA

“What Is Rome?”	“The Legend of Romulus and Remus”	“Roman Gods and Goddesses”	“The Roman Republic”	“The Punic Wars”
-----------------	-----------------------------------	----------------------------	----------------------	------------------

## Week 6

**Day 26**

**Day 27**

**Day 28**

**Day 29**

**Day 30**

### Ancient Rome

“Androcles and the Lion” (TG, Chapter 12, Additional Activities, FE 1 and AP 12.1)	“Pompeii” Core Lesson (TG & SR, Chapter 13)	“Pompeii” (TG, Chapter 13, Additional Activities)	“The Romans and the Christians” Core Lesson (TG & SR, Chapter 14)	“Domain Vocabulary: Chapters 12–14 (TG, Chapter 14, Additional Activities, AP 14.1)”
--	---	---	---	--

### CKLA

“Daily Roman Life in the City, Part I”	“Daily Roman Life in the City, Part II”	“Pausing Point”	“Pausing Point”	“Julius Caesar”
--	---	-----------------	-----------------	-----------------

# ANCIENT ROME SAMPLE PACING GUIDE

For schools using the *Core Knowledge Sequence* and/or CKLA

TG–Teacher Guide; SR–Student Reader; AP–Activity Page; FE–Fiction Excerpt

## Week 7

### Day 31

### Day 32

### Day 33

### Day 34

### Day 35

#### **Ancient Rome**

<p>“The Decline of the Roman Empire” Core Lesson (TG &amp; SR, Chapter 15)</p>	<p>“East and West” Core Lesson (TG &amp; SR, Chapter 16)</p>	<p>“Hagia Sophia” (TG, Chapter 16, Additional Activities)</p> <p>Homework: Domain Vocabulary: Chapters 1-16 (AP 16.1)</p>	<p>“Byzantine Mosaics” (TG, Chapter 16, Additional Activities)</p>	<p>Unit Assessment</p>
--	--	---	--	------------------------

#### **CKLA**

<p>“Julius Caesar: The Last Years”</p>	<p>“Caesar Augustus and the Roman Empire”</p>	<p>“The Decline of the Roman Empire”</p>	<p>“The Western and Eastern Empires”</p>	<p>“Rome’s Lasting Contributions”</p>
--	---	--	--	---------------------------------------



# ANCIENT ROME PACING GUIDE

\_\_\_\_\_’s Class

(A total of thirty-five days have been allocated to the *Ancient Rome* unit in order to complete all Grade 3 history and geography units in the Core Knowledge Curriculum Series™.)

## Week 1

Day 1

Day 2

Day 3

Day 4

Day 5

*Ancient Rome*

--	--	--	--	--

CKLA

--	--	--	--	--

## Week 2

Day 6

Day 7

Day 8

Day 9

Day 10

*Ancient Rome*

--	--	--	--	--

CKLA

--	--	--	--	--

# ANCIENT ROME PACING GUIDE

\_\_\_\_\_ 's Class

## Week 3

Day 11

Day 12

Day 13

Day 14

Day 15

*Ancient Rome*

--	--	--	--	--

CKLA

--	--	--	--	--

## Week 4

Day 16

Day 17

Day 18

Day 19

Day 20

*Ancient Rome*

--	--	--	--	--

CKLA

--	--	--	--	--

## Week 5

Day 21

Day 22

Day 23

Day 24

Day 25

*Ancient Rome*

--	--	--	--	--

CKLA

--	--	--	--	--

# ANCIENT ROME PACING GUIDE

\_\_\_\_\_’s Class

## Week 6

Day 26

Day 27

Day 28

Day 29

Day 30

*Ancient Rome*

--	--	--	--	--

CKLA

--	--	--	--	--

## Week 7

Day 31

Day 32

Day 33

Day 34

Day 35

*Ancient Rome*

--	--	--	--	--

CKLA

--	--	--	--	--

# Romulus and Remus

**The Big Question:** According to legend, how did the city of Rome begin?

## Primary Focus Objectives

- ✓ Retell the legend of Romulus and Remus. (RL.3.2)
- ✓ Explain how the city of Rome began. (RI.3.3)
- ✓ Explain the meanings of BCE and CE and BC and AD. (RI.3.4)
- ✓ Read a map to learn the geography of the Mediterranean region and the extent of Roman control. (RI.3.7)
- ✓ Understand the meaning of the following domain-specific vocabulary: *capital*, *legend*, *king*, and *representative*. (RI.3.4)

## What Teachers Need to Know

For more background information, download the CKHG Online Resource “About Romulus and Remus”:

[www.coreknowledge.org/ckhg-online-resources](http://www.coreknowledge.org/ckhg-online-resources)

 **Note:** Prior to conducting this Core Lesson in which students read Chapter 1 in the *Ancient Rome* Student Reader, we strongly recommend that you first conduct the activities titled World Map and World Geography, using AP 1.1 and 1.2, and Map of the Mediterranean Region and Geography of the Mediterranean Region, using AP 1.3 and 1.4. These activities are described at the end of this lesson under Additional Activities. By first providing students with an understanding of the geographical features of the Mediterranean region, such as the sea, mountains, rivers, and coastline, they will be able to more fully appreciate the size and geographic diversity of the Roman world.

## Materials Needed

Activity Pages



AP 1.1  
AP 1.2  
AP 1.3  
AP 1.4

- World Map (AP 1.1), World Geography (AP 1.2), Map of the Mediterranean Region (AP 1.3), and Geography of the Mediterranean Region (AP 1.4), found in Teacher Resources, pages 137–140. (**Note:** the World Map and Map of the Mediterranean Region will be used again in Chapters 4, 6, 7, and 9)
- enlarged versions of the activity page maps
- colored pencils

## Core Vocabulary (Student Reader page numbers listed below)

---

**capital, n.** the main city of a country and the home of the country's government (2)

*Example:* The city of Rome is the capital of the country of Italy.

*Variation(s):* capitals

**legend, n.** an old, well-known story, usually more entertaining than truthful (2)

*Example:* The legend of Romulus and Remus helped to explain the founding of Rome.

*Variation(s):* legends

**king, n.** a male ruler who comes to power by birth and who rules for life (6)

*Example:* Rome was ruled by kings for more than two hundred years.

*Variation(s):* kings

**representative, n.** a person who speaks or acts for someone else (6)

*Example:* The people of Rome chose representatives to rule the city for them.

*Variation(s):* representatives

### THE CORE LESSON 25 MIN

## Introduce the *Ancient Rome* Student Reader

5 MIN

Distribute copies of the *Ancient Rome* Student Reader and suggest students take a few minutes to look at the cover and flip through the Table of Contents and illustrations in the book. Ask students to identify people, places, and events they notice as they browse; record this information in a three-column chart on the board or chart paper. Students may mention the Punic Wars, Julius Caesar, Cleopatra, and the Mediterranean Sea, for example.

Explain to students that they will be reading about a time in history that is considered ancient, or classical: the era of Roman civilization. Roman civilization was in some ways inspired by Greek civilization, the other civilization of the classical era. For example, many Roman gods were the same as the Greek deities but given Roman names.

## Introduce “Romulus and Remus”

5 MIN

**Note:** Each student will need a red pencil.

Have students refer to AP 1.3, Map of the Mediterranean Region. You may also want to display the enlarged version of this activity page for students to look at while you introduce the chapter.

Activity Page



AP 1.3

Orient students by pointing out the Italian peninsula on the map. Ask students to locate and circle Rome on the map of the activity page with their red pencil. Point out that today Rome is a city in the country of Italy.

Explain that in this chapter, they will learn about the founding of Rome. **Ask:** What do you notice about Rome’s location? Do you think it is a good place to put a city? Why or why not?

Next, call students’ attention to the Big Question. Ask students to think about the term *legend*. Students who participated in this history program in earlier grades will likely remember learning about the legend of George Washington and the cherry tree, as well as the legend of Betsy Ross and the flag. **Ask:** What is a legend? What legends do you already know? How can we tell the difference between a legend and history? (*For example, students may say that a legend would involve magical or supernatural events, while history might include specific dates or information about real people, places, and events.*) List these criteria on the board or on chart paper. Encourage students to refer to and apply the criteria as they read the chapter.

## Guided Reading Supports for “Romulus and Remus”

15 MIN

When you or a student reads aloud, **always** prompt students to follow along. By following along, students may acquire a greater understanding of the content. Remember to provide discussion opportunities.

### “Now and Then” and “The Legend of Romulus and Remus,” Pages 2–5

Scaffold understanding as follows:

**CORE VOCABULARY**—Invite a volunteer to read the “Now and Then” section on page 2 aloud. Discuss the meaning of the word *capital* when encountered in the text. Note that the word comes from a Latin word meaning “head.”

**CORE VOCABULARY**—Also point out the word *legend*, and ask students to identify the context clue that defines the word for them.

**Read aloud the subhead “The Legend of Romulus and Remus.” After reading the text, ask the following questions:**

**LITERAL**—Who were Romulus and Remus? What happened to them?

- » Romulus and Remus were the twin sons of the Roman god Mars. They were kidnapped and put in the river. They were saved by a mother wolf and raised by a shepherd.

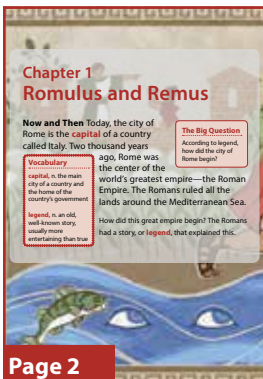

**The Legend of Romulus and Remus**

Mars, the Roman god of war, had twin sons named Romulus and Remus. When the twins were born, Mars promised that they would someday start a great empire.

A jealous uncle kidnapped the baby boys. He asked a servant to drown them in the Tiber River. The servant took pity on the boys. Instead of drowning them, he put them in a reed basket. He placed the basket in the river.

The twin boys were lucky. As the basket floated down the river, it drifted toward the riverbank. The basket hit the riverbank, and Romulus and Remus fell out. Then something moved in the bushes near the shore. It was a mother wolf! She had heard the babies crying. She nudged them with her nose and then with her paw. The wolf saw that the twins were hungry. She fed them milk just as she fed her own cubs.



**Page 4**

Later, a shepherd found the boys and raised them as his own sons. After the boys grew up, they decided to build a city near the Tiber River where the wolf had found them.

The brothers began to argue. They fought over where to start building the city. During this fight, Romulus killed Remus. Romulus became the first king of the city, which would be named after him—Rome.

Romulus ruled Rome for many years, until he disappeared during a storm. The Romans believed that his father, the god Mars, took Romulus into heaven. There, Romulus became a god too.



**Page 5**

**SUPPORT**—Do you think what you just heard is fact or fiction? (Ask students to cite passages from the text to support their responses).

» Students may cite passages such as those describing the actions of the wolf mother that suggest the story is fictional.

**LITERAL**—How did Romulus and Remus choose the location for Rome?

» They chose the location where the wolf had found and saved them.

**LITERAL**—How did Romulus become the first king of Rome?

» Romulus became king after killing his brother, Remus.

**INFERENTIAL**—Why would the Romans want to believe their city was founded by a god?

» The Romans wanted to believe their city was founded by a god because that would make their city important.

## “The Early Years,” Pages 6–7

**The Early Years**

The story of Romulus and Remus is a legend. Legends usually are not true stories. Rome was built near the Tiber River, but probably not because a wolf helped twins there. So what really happened? Rome probably began when some farmers and shepherds built a village of small huts on one of the seven hills near the Tiber River. These people probably settled by the Tiber because it was a good place to live. The soil was rich. There was plenty of water, and the river was good for travel. An island in the river near the village made crossing the river easier.

The seven hills around the Tiber made it hard for enemies to attack. Rome grew as more people settled on those hills. That is why Rome became known as the “City of Seven Hills.”

According to legend, Rome was founded in 753 BCE. The letters BCE stand for “Before the Common Era.” The Common Era began when Jesus Christ was born. So Rome was founded 753 years before the birth of Jesus. That means Rome is more than 2,750 years old.

For many years, kings ruled Rome. Over time the kings became greedy for power. In 509 BCE the Romans drove out their king. They decided not to trust anyone else to be king. Instead, the Romans made their city a republic. In a republic, people choose representatives to rule for them.

**Vocabulary**

**king**, a male ruler who comes to power by birth and who rules for life

**representative**, a person who speaks on behalf for someone else

**Page 6**

**Scaffold understanding as follows:**

**CORE VOCABULARY**—Read aloud the last paragraph in this section. Ask students if they know the female counterpart of the term *king*. (*queen*)

**CORE VOCABULARY**—Explain the meaning of the word *representative*. Tell students that people in the United States also have representatives in their state and national governments.

**Have students read the entire section to themselves. After they have finished, ask the following questions:**

**LITERAL**—Why was Rome’s location a good place to build a city?

» It had rich soil. The river provided water and a way to travel. The hills provided protection.

 **LITERAL**—Look at the map of Roman Lands in about 130 BCE on page 7 of the Student Reader. About how many miles, from east to west, did the Roman Empire reach by 130 BCE?

» It stretched nearly 2,400 miles from east to west.

**Roman Lands, About 130 BCE**



Over time, Rome came to control a large area around the Mediterranean Sea.



**Page 7**

**CHALLENGE**—What other world rivers have we learned about that also prompted the establishment of cities near these rivers?

- » We have learned about the Nile River in Africa, the Yellow River in Asia, the Amazon in South America, and many other rivers where people settled long ago.

**LITERAL**—What does *BCE* mean?

- » Before the common era, or before the birth of Jesus

**SUPPORT**—According to the legend, Rome was established in 753 BCE. Does that mean that Rome was established a long, long time ago or not too long ago?

- » Rome was established a long, long time ago—in fact, thousands of years ago!

**EVALUATIVE**—What is the difference between a representative and a king?

- » A representative is chosen by the people. A king is chosen by birth.

## Timeline

---

- Show students the Chapter 1 Timeline Image Cards. Read and discuss the captions, making particular note of any dates.
- Review and discuss the Big Question: “According to legend, how did the city of Rome begin?”
- Post the image cards as the first two images on the far left of the Timeline, under the date referencing 800–501 BCE; refer to the illustration in the Unit 2 Introduction for further guidance on the placement of each image card to the Timeline.



### CHECK FOR UNDERSTANDING 5 MIN

**Ask students to do one of the following:**

- **Turn and Talk**—Ask a partner the answer to the Big Question, “According to legend, how did the city of Rome begin?”
  - » Key points students should cite include: Romulus and Remus were the twin sons of a Roman god. They were kidnapped and placed in a basket on the Tiber River. The basket ran aground. The boys were found by a wolf. The wolf kept them alive until they were found by a shepherd. The shepherd raised the boys. When Romulus and Remus grew up, they built a city on the site where the wolf found them. Later, Romulus killed Remus in a fight and became king of Rome.



- Choose one of the Core Vocabulary words (*capital, legend, king, or representative*), and say a sentence aloud using the word.

To wrap up the lesson, ask several students to share their responses.

## Additional Activities



### World Geography (RI.3.7)

30 MIN

#### Activity Pages



AP 1.1  
AP 1.2



**Background for Teachers:** Before beginning this activity, review “What Teachers Need to Know” on pages 3–7 of the Introduction. This activity is best introduced prior to teaching the Chapter 1 Core Lesson, so it can serve as an introduction for students to the basics of world geography.

**Materials Needed:** (1) Display copy of the World Map (AP 1.1) and (2) sufficient copies of World Map (AP 1.1) and World Geography (AP 1.2), found in Teacher Resources section (pages 137–138); plus (3) colored pencils or markers.

Display the enlarged World Map for all students to see. Point first to the compass rose, and review each of the cardinal directions—north, south, east, and west—relative to the map. Point to the bar scale on the map. Ask students to identify its purpose (*to determine distance*).

Identify the equator on the map. Remind students that the equator marks the boundary between the Northern and Southern Hemispheres. Ask students to identify the continents that exist solely in the Northern Hemisphere (*Europe, North America*).

Then point to the United States and the approximate location of the state in which your students live to identify their current location.

Next, point to each of the continents in the following order, asking students to verbally identify each continent: North America, South America, Antarctica, Australia, Asia, Africa, Europe. Point out the Mediterranean Sea. Tell students that during the next several weeks, as they learn about ancient Rome, they will focus primarily upon the areas surrounding the Mediterranean Sea.

Ask students to explain how the map shows the difference between land, such as the continents, and bodies of water, such as the Mediterranean Sea. Ask students to identify other bodies of water shown on the map (*Pacific Ocean, Atlantic Ocean, Indian Ocean, Arctic Ocean*).

Distribute copies of the World Map (AP 1.1) and World Geography (AP 1.2) to all students. Ask students to use the World Map to answer the questions on the World Geography activity page. Depending on your students’ map skills, you may choose to do this as a whole-class activity so that you can scaffold and provide assistance, or you may choose to have students work with partners or small groups. If students work with partners or small groups, be sure to review

the answers to the questions with the whole-class. If students are able to work more independently after the whole-group review, you might also consider assigning AP 1.1 and AP 1.2 for homework.



## Geography of the Mediterranean Region (RI.3.7)

30 MIN

Activity Pages



AP 1.3

AP 1.4



**Background for Teachers:** Before beginning this activity, review “What Teachers Need to Know” on pages 3–7 of the Introduction. This activity is best introduced prior to teaching the Chapter 1 Core Lesson, so it can serve as an introduction for students to the geography of the Mediterranean world.

**Materials Needed:** (1) Display copy of the Map of the Mediterranean Region found in the Teacher Resources section (page 139), (2) sufficient copies of the Map of the Mediterranean Region (AP 1.3) and Geography of the Mediterranean Region, (AP 1.4, page 140); and (3) colored pencils or markers.

Display the enlarged Mediterranean Region map for all students to see, and distribute the Map of the Mediterranean Region (AP 1.3). Point out the compass rose and bar scale. Tell students to remember the location of these elements, as they will need them later in the activity.

Point out the key on the map. Invite students to trace these rivers using a blue pencil on their Map of the Mediterranean Region activity page. Also point out the symbols for mountains (^^^), and ask students to locate the Pyrenees and Alps. Have students use a brown pencil to shade in these areas. Invite students to identify the countries these mountains separate. (*The Pyrenees separate Spain and France, and the Alps separate Italy from its neighbors to the north, including France and other northern countries on the continent of Europe.*)

Ask a volunteer to identify the location of the Mediterranean Sea, and direct students to shade this area blue on their activity pages. Point out the other bodies of water that touch the Mediterranean: the Adriatic Sea, the Aegean Sea, and the Black Sea. Point out the countries Italy, Greece, Turkey, and Egypt. Have students shade these areas, as well. Ask: On what landform is Turkey located? (*Asia Minor*) If you traveled from Italy to Greece, what body of water would you need to cross? (*Adriatic Sea*)

Point out the location of Rome. Ask students to describe Rome’s location. (*It is in Italy, in the middle of the peninsula shaped like a boot; it is near the west coast of Italy*). Tell students that during the next several weeks, they will learn about ancient Rome and the lands it controlled. Explain that Rome controlled much of the land shown on the map, including the modern countries of Spain and France. It also had strong ties with Egypt and fought a series of wars with Carthage. Point out each of these locations as you mention them.

Next, distribute the Geography of the Mediterranean Region (AP 1.4) to all students. Ask students to use the map to answer the questions on the activity page. Depending on your students' map skills, you may choose to do this as a whole-class activity so that you can scaffold and provide assistance, or you may choose to have students work with partners or small groups. If students work with partners or small groups, be sure to review the answers to the questions with the whole class. If students are able to work more independently after the whole-group review, you might also consider assigning AP 1.4 for homework.



## Romulus and Remus Comic (RL.3.2)

30 MIN

Activity Page



AP 1.5

**Materials Needed:** (1) Sufficient copies of The Legend of Romulus and Remus (AP 1.5, page 141), or access to the Read•Write•Think Comic Creator; (2) sufficient blank paper for initial sketches; (3) colored pencils or markers; (4) examples of comic books and/or graphic novels.

Use this link to download the CKHG Online Resources for this unit, where the specific link to the Read•Write•Think Comic Creator may be found.

[www.coreknowledge.org/ckhg-online-resources](http://www.coreknowledge.org/ckhg-online-resources)

Review with students the elements of comics and graphic novels. Using examples that you have on hand, point out that comics and graphic novels are primarily visual forms of storytelling. The images tell the story, and the words provide support. Note that this is the opposite of how information is presented in the Student Reader, where the words tell the story and the images provide support.

Point out that comics and graphic novels are divided into panels. Each panel represents an important event in the story. Note that panels differ in size, depending on the importance and complexity of the scene being presented. Some panels use captions. Some use speech or thought bubbles. Some do not have any text at all.

Tell students they will be creating their own comic that tells the story of Romulus and Remus. Organize students into pairs. Give students time to work with their partners to discuss what parts of the Romulus and Remus story they will show in different scenes. Each scene should become one panel in their comics.

Students should sketch out or storyboard their comic before drawing their final version on The Legend of Romulus and Remus (AP 1.5). You may wish to provide enlarged versions of the template on AP 1.5. Students may also create their cartoons on larger pieces of paper, or on several sheets of paper, as required.

You might also wish to offer students the opportunity to create their comics digitally using the Read•Write•Think Comic Creator.

If time permits, invite students to share their comics. You might also combine the student comics into a class book or bulletin board display.

 **Background for Teachers:** Before beginning this activity, review “Understanding References to Time in the *Ancient Rome Unit*” on page 10 of the Introduction.

**Materials Needed:** Large index cards or sentence strips, each with one of the following dates: 753 BCE, 100 BCE, 44 BCE, 1 BCE, 1 CE, 100 CE, 300 CE, 476 CE.

On the board or chart paper, draw a timeline with a black marker. Review with students what a timeline is and how it is used.

Add a notch to the middle of the timeline. Label the notch “the birth of Jesus.” Explain that many historians use a calendar that is based on the birth of Jesus. Dates that happened before the birth of Jesus are labeled BCE—Before the common era. In some sources, these dates are labeled BC (Before Christ). Use a color marker to note the part of the timeline that represents BCE.

Using a second color, mark the part of the timeline that represents the years after the birth of Jesus. Explain that these dates are called the common era, or CE. Sometimes these dates are labeled AD, for *Anno Domini* (Year of Our Lord).

Ask: Do we live in BCE or CE? (CE) Was Rome founded in BCE or CE? (BCE).

Explain that while CE years count up, or forward, BCE years count down, or backward. For example, the year 200 BCE happened before the year 100 BCE. Use the timeline to illustrate this concept. To check students’ understanding, give them pairs of BCE dates, and ask them to identify which date came later.

Choose eight volunteers. Give each volunteer one of the cards or sentence strips. Tell the volunteers to arrange themselves in chronological order. Encourage the rest of the class to coach the volunteers into the correct order, using the timeline on the board as a guide.

# Roman Gods and Goddesses

**The Big Question:** What does this story tell you about the importance of gods in the lives of Romans?

## Primary Focus Objectives

---

- ✓ Describe the role of gods and goddesses in the Roman belief system. **(RI.3.2)**
- ✓ Identify Juno, Mars, Vesta, and Janus as Roman gods. **(RI.3.2)**
- ✓ Understand the meaning of the following domain-specific vocabulary: *god, goddess, holy, temple, sacred, symbol, ember, and charcoal*. **(RI.3.4)**

## What Teachers Need to Know

---

For background information, download the CKHG Online Resource “About Roman Deities”:

[www.coreknowledge.org/ckhg-online-resources](http://www.coreknowledge.org/ckhg-online-resources)

## Core Vocabulary (Student Reader page numbers listed below)

---

**god, n.** a being in the shape of a man who has the power to affect nature or people’s lives **(8)**

*Example:* Romulus and Remus were the sons of Mars, the Roman god of war.

*Variation(s):* gods

**goddess, n.** a being in the shape of a woman who has the power to affect nature or people’s lives **(10)**

*Example:* The Romans believed the goddess Vesta watched over their homes.

*Variation(s):* goddesses

**holy, adj.** having to do with a god or religion **(10)**

*Example:* Homes kept a holy fire burning to honor the goddess Vesta.

**temple, n.** a building used for worship **(11)**

*Example:* The Temple of Vesta in the Roman Forum honored the Roman goddess of the hearth and home.

*Variation(s):* temples

**sacred, adj.** related to religion; holy (11)

*Example:* The fire that honored the goddess Vesta was sacred.

**symbol, n.** a picture or object that is a sign for something; for example, the American flag is a symbol of the United States (12)

*Example:* Fire was the symbol of the goddess Vesta, who watched over the hearth.

*Variation(s):* symbols

**ember, n.** a small piece of burning wood or coal from a dying fire (12)

*Example:* If a fire is not tended, it will die down to embers.

*Variation(s):* embers

**charcoal, n.** black chunks made from burned wood that are used as a fuel (12)

*Example:* The Romans believed that burning charcoal would bring the goddess Vesta to watch over their homes.

## THE CORE LESSON 25 MIN

### Introduce “Roman Gods and Goddesses”

5 MIN

In a brief class discussion, ask what students remember about Greek gods and goddesses that they learned about in Grade 2. Explain that while the Romans worshipped some of the same gods as the Greeks, the Romans had different beliefs about the gods and worshipped the gods in different ways.

Call students’ attention to the Big Question. Suggest that as they read, they look for the names of Roman gods and goddesses and details about how the Romans honored them.

### Guided Reading Supports for “Roman Gods and Goddesses”

20 MIN

When you or a student reads aloud, **always** prompt students to follow along. By following along, students may acquire a greater understanding of the content. Remember to provide discussion opportunities.

## "The Mighty Gods," Pages 8–10

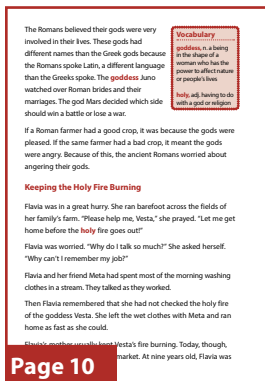
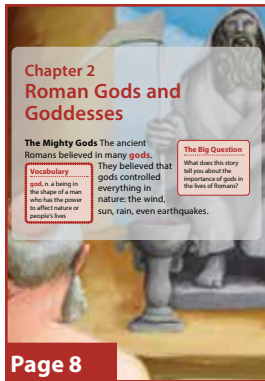

### Scaffold understanding as follows:

**CORE VOCABULARY**—On page 10, note the meaning of the word *god*. Explain that the plural form of the word can refer to both males and females. Examine and discuss the chapter opener illustration with students.

**CORE VOCABULARY**—On page 12, note that *goddess* is often used when speaking about gods who have female appearance or qualities.

### Read aloud the entire section. Then, ask the following questions:

**LITERAL**—Who were Juno, Mars, and Saturn?

- » They were Roman gods. Juno was the goddess of brides and marriages. Mars was the god of war. Saturn was the god of the harvest.

**INFERENCE**—If a Roman farmer had a good crop, which particular Roman god might he thank?

- » A successful Roman farmer would thank Saturn.

**INFERENCE**—If a Roman general were getting ready to march into battle, to which particular Roman god might he ask for help?

- » A Roman general planning for battle might seek the help of Mars.

**LITERAL**—Why did the Romans have different names for their gods than the Greeks did?

- » The Romans spoke a different language than the Greeks did.

## “Keeping the Holy Fire Burning,” Pages 10–13

### Scaffold understanding as follows:

**SUPPORT**—Help students recognize that this section, “Keeping the Holy Fire Burning,” is a bit of historical fiction. It describes the experiences of a young girl named Flavia. This person did not really exist, but her experiences are typical of what a young girl of this time period might have lived through.

**CORE VOCABULARY**—Review the meaning of the word *holy*. Ask volunteers to share examples of things that are holy in their own belief systems or belief systems they know about. Point out that different religions consider different objects and practices holy. Suggest students look for examples of what the Romans considered holy as they read the section “Keeping the Holy Fire Burning.”

**Read aloud the section “Keep the Holy Fire Burning” as students follow along. Pause to explain the following Core Vocabulary words as they are encountered: temple, sacred, symbol, embers, and charcoal.**

**CORE VOCABULARY**—Observe the terms *temple* and *sacred* that appear on page 11. Define each term separately. Have students use both these terms in a sentence (*for example, The sacred fire burned in the temple.*)

**CORE VOCABULARY**—Note the term *symbol* on the top of page 12. Direct students to the image on the bottom of the page, and point out that it is a symbol of Janus.

**CORE VOCABULARY**—Direct students to the two terms *ember* and *charcoal*. Read the definitions of both words separately. Then, explain how by burning charcoal, you obtain embers.

### Then, ask the following questions:

**LITERAL**—Who was Vesta?

- » Vesta was a Roman goddess who watched over Roman homes and fires.

**LITERAL**—What happened to Flavia in this story?

- » Flavia had lost track of time while she was washing her family’s clothes. As a result, she was anxious to get home in time to meet her responsibility for tending the fire dedicated to the goddess Vesta.

**EVALUATIVE**—Why did Flavia need to keep Vesta’s fire burning?

- » The fire was holy or sacred. It was how the Romans honored the goddess. Without the fire, Vesta would not protect their homes.

**INFERENCE**—(Explain that words with similar meanings are called *synonyms*.) Which word in the section is a synonym for *holy*?

- » *Sacred* is the synonym for *holy* in this section.



The Temple of Vesta was one of the many buildings in an area of Rome called the Forum.

the oldest daughter. It became her job to keep the holy fire burning at home, just as it did in the temple.

The goddess Vesta watched over the sacred fire of Roman homes and the Forum.

**Vocabulary**  
*temple*, a building used for worship  
*sacred*, adj. related to religion; holy

**Page 11**

male statues of Vesta. Fire was her only symbol. The Romans worshipped Vesta at every meal by throwing food into their fires.

Flavia burst into the house. She rushed to the fire. There she found just a few glowing embers. Quickly but carefully, she placed some straw on the embers. She blew gently to bring the flames back to life. Soon the fire burned brightly once again.

“Oh, thank you, Vesta!” Flavia cried. She placed more twigs on the burning straw. When the twigs were blazing, she put some charcoal in the fire. Flavia and her family believed that the smell of burning charcoal meant that Vesta was watching over the family.

Flavia and her family felt very close to Vesta and to the god Janus (JAY’nyus’), who also watched over Roman homes. Janus was a special god with two faces: one in the front of his head and one in the back.

**Vocabulary**  
*symbol*, a picture or object that is a sign for something  
*temple*, a building used for worship  
*charcoal*, n. black, dark, made from burned wood that is used as a fuel



This Roman coin shows the god Janus, Janus watched over Roman homes and the Forum in Rome.

**Page 12**

back. With his two faces, Janus watched over the beginning and the end of all things. He also watched who came in and who went out of every building.

Later, Flavia again thanked the gods that the holy flame had not died out. If it had, her family would have been disgraced. She was very grateful that the gods had saved her. She promised them she would never forget again.

**Page 13**



**INFERENTIAL**—If the fire had gone out, couldn't Flavia have just lit a new one and not let anyone know? Why wouldn't this have been a good solution to the problem?

- » Flavia believed that Vesta would know if the fire went out and that Vesta would be angry.

**SUPPORT**—What did Flavia believe would happen if Vesta's fire had gone out?

- » Her family would be disgraced.

**SUPPORT**—Looking at the photo of the god Janus on page 12, what do you notice?

- » Janus has two faces.

**LITERAL**—Why does Janus have two faces?

- » Janus's two faces allow him to watch the beginning and ending of all things; they let him watch who enters and leaves every building.

**EVALUATIVE**—How were Vesta and Janus the same? How were they different?

- » Both Vesta and Janus watched over Roman homes. However, Vesta was a goddess and Janus was a god. Vesta did not have any statues—she was represented only by fire. Janus, however, did have statues and coins—ones that showed his two faces.



## CHECK FOR UNDERSTANDING 5 MIN

**Ask students to do one of the following:**

- **Turn and Talk**—Tell a partner the answer to the Big Question, “What does this story tell you about the importance of gods in the lives of Romans?”
  - » Key points students should cite include: The Romans believed the gods involved themselves in their daily life. Romans honored the gods every day by tending a fire honoring Vesta and feeding parts of their meals to the fire. They believed that if Vesta's fire went out, their families would be disgraced.
- Choose one of the Core Vocabulary words (*god, goddess, holy, temple, sacred, symbol, ember, or charcoal*), and say a sentence aloud using the word.

To wrap up the lesson, ask several students to share their responses.

## Additional Activities

### The *Di Consentes* (W.3.7)

30 MIN

 **Background for Teachers:** The *Di Consentes*, or *Dei Consentes*, are the twelve most important gods and goddesses in the Roman state religion: Jupiter, Mars, Mercury, Neptune, Vulcan, Apollo, Juno, Vesta, Minerva, Ceres, Diana, and Venus. Three of these deities—Jupiter, Juno, and Minerva—are known as the Capitoline Triad because all three were worshipped in the Temple of Jupiter on Rome’s Capitoline Hill. Students will read more about the Temple of Jupiter in Chapter 11 of the *Ancient Rome* Student Reader.

**Materials Needed:** (1) Twelve Pieces of poster board or chart paper, (2) colored markers or crayons, (3) reference materials that include information about Roman religion and/or Internet access. See page 14 for a list of possible print resources, or use this link to download the CKHG Online Resources for this unit, where a specific link to a website about Roman religion may be found:

[www.coreknowledge.org/ckhg-online-resources](http://www.coreknowledge.org/ckhg-online-resources)

Organize students into twelve groups. Assign each group one of the following twelve Roman deities: Jupiter, Mars, Mercury, Neptune, Vulcan, Apollo, Juno, Vesta, Minerva, Ceres, Diana, and Venus.

Ask each group to research their assigned god or goddess and create a poster that includes the name of the god or goddess, an image of the god or goddess, and the responsibilities of the god or goddess. If the information is readily available, students might also include information about how the god or goddess was worshipped.

Display the posters in the classroom.

### The Solar System (SL.3.2)

30 MIN

Activity Page



AP 2.1

 **Background for Teachers:** The names of planets and their moons are decided by an organization called the International Astronomical Union (IAU). The IAU named most of the objects in our solar system based on Greek and Roman mythology.

**Materials Needed:** (1) Display copy of The Solar System (AP 2.1) and (2) sufficient copies for all students of The Solar System (AP 2.1), found in the Teacher Resources section (pages 142–143).

**Note:** Students using curriculum based on the *Core Knowledge® Sequence* will have already been introduced to the concept of the solar system in Grade 1 science and should be familiar with this term. If your students have not already studied the solar system, you may need either to provide additional context and background information or to skip this optional activity page.

Display The Solar System map. Ask students to read to themselves the names of the planets. Ask: Where do you think these names came from? (*Roman and Greek mythology*) Note that the ancient Greeks spoke the ancient Greek language and that the Romans spoke Latin. Explain that scientists chose names from Greek and Roman mythology because they wanted to recognize that astronomy—the study of the stars—is an old science.

Distribute copies of The Solar System (AP 2.1). Ask students to complete the chart as you explain why each of the following planets was given its name:

Mercury is the Roman god of trade. He is based on the Greek god Hermes, who was known for his speed. The planet was given this name because it moves so quickly across the sky.

Venus is the Roman goddess of love and beauty. The planet was given this name because of its brightness in the sky. Only the sun and moon are brighter.

Mars is the Roman god of war. The planet was given this name because of its red color. Red is the color of blood, and a lot of blood is shed in a war.

Jupiter is the king of the Roman gods. The planet was given this name because it is the largest planet in the solar system. It has four large moons. Each moon is named for a mythological character who played a part in Jupiter's life.

Saturn is the Roman god of agriculture and time. He is also Jupiter's father. The planet was probably given this name because it is the slowest to orbit the sun.

Neptune is the Roman god of the sea. The planet was given this name because it looks blue, the color of the sea.

**CHALLENGE:** If time remains, ask students to recall which of these gods and goddesses they read about in the chapter.

- » Mars, the Roman god of war, and Saturn, the Roman god of agriculture and time

Ask students to recall the names of any gods and goddesses whom they read about in the chapter but for whom none of the planets are named.

- » Juno, the goddess of marriage and brides, Vesta, the goddess of fire, and Janus, the god of the beginning and ending of all things

**Note:** Students using curriculum based on the *Core Knowledge® Sequence* will study about all of the planets in science. You may want to foreshadow that unit by telling them that there are actually two other planets in the solar system—Earth and Uranus—that are not named after Roman gods or goddesses.

# The Roman Republic

**The Big Question:** In ancient Rome, what was the difference between patricians and plebeians?

## Primary Focus Objectives

- ✓ Identify patricians and their role in Roman society. (RI.3.2)
- ✓ Identify plebeians and their role in Roman society. (RI.3.2)
- ✓ Explain the role of the Senate in the Roman Republic. (RI.3.2)
- ✓ Understand the meaning of the following domain-specific vocabulary: *chariot*, *patrician*, *senator*, *citizen*, *plebeian*, *republic*, *assembly*, *Senate*, *consul*, *dictator*, and *Forum*. (RI.3.4)

## What Teachers Need to Know

For background information, download the CKHG Online Resource “About Founding of Republic”:

[www.coreknowledge.org/ckhg-online-resources](http://www.coreknowledge.org/ckhg-online-resources)

This chapter explains the workings of the early Roman Republic. In the early republic, only patricians served as consuls. However, in later years—specifically, by the fourth century—there were consuls from plebeian families too.

## Core Vocabulary (Student Reader page numbers listed below)

**chariot, n.** a carriage with two wheels that was pulled by horses or other animals (16)

*Example:* Racing in horse-drawn chariots was a popular sport in Rome, but chariots were also used in parades.

*Variation(s):* chariots

**patrician, n.** a member of ancient Rome’s highest social class; a wealthy landowner in ancient Rome (17)

*Example:* In the early Roman Republic, the patricians held the most power.

*Variation(s):* patricians

**senator, n.** a member of the Senate, the patrician lawmaking group in ancient Rome (17)

*Example:* Hundreds of senators served in the Roman Senate during any given year.

*Variation(s):* senators

**citizen, n.** person who belongs to a country and has protections under that country's laws (17)

*Example:* A Roman citizen enjoyed many rights.

*Variation(s):* citizens

**plebeian, n.** a common person without power in ancient Rome (17)

*Example:* A free Roman citizen who was not a member of the patrician class was a plebeian.

*Variation(s):* plebeians

**republic, n.** a kind of government where people elect representatives to rule for them (17)

*Example:* Because they did not trust kings, the Romans made their city a republic.

**assembly, n.** a group of people that makes laws (18)

*Example:* The assembly gathered to make laws for the people of Rome.

*Variation(s):* assemblies

**Senate, n.** the patrician lawmaking group in ancient Rome; the most powerful group in the Roman Republic (18)

*Example:* The Senate had the most power in the government of the Roman Republic.

**consul, n.** the most important official in the Roman Republic (19)

*Example:* In the Roman Republic, the consul served as leader of the Senate and made sure the Senate's laws were carried out.

*Variation(s):* consuls

**dictator, n.** a ruler who has total control over the country (19)

*Example:* During times of war or crisis, the Roman Senate could choose a dictator to rule with absolute power until the crisis was over.

*Variation(s):* dictators

**Forum, n.** the area in the center of Rome where government buildings, temples, and other important monuments were built (19)

*Example:* The Roman Senate met in a building in the Roman Forum.

## Introduce “The Roman Republic”

5 MIN

Remind students that when Rome was first founded, it was governed by kings. Go back to Chapter 1, and reread the last paragraph about how greedy kings were replaced by a representative government. Tell students that in this chapter, they will learn how that representative government—known as the Roman Republic—worked.

Review with students the concept of historical fiction. Explain that Lucius (/loo\*shee\*us/) is not a real historical figure but that his experiences are representative of a patrician boy of that time and place. Note: Students using a curriculum based on the *Core Knowledge® Sequence* will have already studied about the American Revolution in Grade 1 and the U.S. Constitution in Grade 2 and will therefore have some understanding of how a representative government differs from one that is ruled by a king.

Call students’ attention to the Big Question. Suggest that as they read, they look for details about patricians and plebeians.

## Guided Reading Supports for “The Roman Republic”

20 MIN

When you or a student reads aloud, **always** prompt students to follow along. By following along, students may acquire a greater understanding of the content. Remember to provide discussion opportunities.

### “A Boy Visits Rome,” Pages 14–17

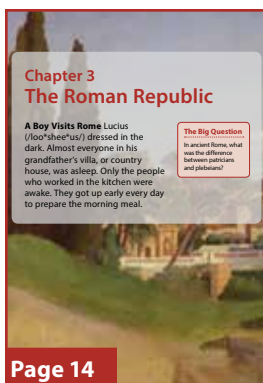

Read the whole section aloud, making sure to create a tone of suspense as you read.

Scaffold understanding as follows:

**CORE VOCABULARY**—After reading the first paragraph at the top of page 16, refer students to the definition of *chariot*, and discuss. Point out that an adult’s chariot would be pulled by a horse, but because Lucius was driving a child’s chariot, that chariot would be pulled by a smaller animal—a goat.

Lucius was about to try driving a chariot. It was a children's chariot, towed by a goat instead of a horse. Still, he was very excited.

Lucius ran barefoot over the stone floor of the villa. He carried his sandals until he reached the path through the outer garden. He put on his sandals and followed the path to a long driveway.

Simon, a Greek servant who worked for Lucius's family, waited by the chariot holding the long reins. Simon was Lucius's friend and teacher.

"Go slowly until you reach the road," Simon warned.

Lucius gripped the reins. He almost fell off when the chariot lurched forward. The chariot quickly reached full speed. Simon ran behind, shouting.

It was a wild ride. Lucius eventually got the goat under control. He was able to guide the chariot in a large circle, back to the villa. There he saw Simon, looking embarrassed. He also saw his father, looking angry.



Lucius's family

**Page 16**

**Vocabulary**  
chariot, n. a carriage with two wheels that was pulled by horses or other animals

**After reading the section, ask the following questions:**

**LITERAL**—What do we know about Lucius's life?

- » He lives in his grandfather's house in the country. His family has a Greek servant. He is up early to try driving his own chariot.

**EVALUATIVE**—What type of boy is Lucius?

- » Students might describe Lucius as eager, energetic, sneaky, and disobedient.

**LITERAL**—Where is Lucius's father going to take him today?

- » Rome

"Your mother better not hear of this, boy!" said Lucius's father. "Simon, take this goat back to the field. Lucius, go inside and find a warm cape. We go to Rome today."

"Yes, Father," said Lucius, and he ran to find his cape. Today he would ride in his father's chariot, too!

**Patricians and Plebeians**

Lucius was a patrician (pə'trɪʃiən/ˈhʌm/). That meant that his family had great wealth and power. His grandfather was a Roman senator. His father was an army commander who had led a legion of five to six thousand soldiers. The family villa was surrounded by a large farm. Hundreds of enslaved people worked on this farm making olive oil and wine. Lucius's family sold the oil and wine in nearby Rome.

Only a very few Roman families were patricians. These families were very powerful. They controlled the government and the army.

What about ordinary Roman citizens? These people were called plebeians (plē'bēiən/uhnz/). Most plebeians were poor working men and women.

patricians had  
they guarded their



**Page 17**

**Vocabulary**  
patrician, n. a member of ancient Rome's highest social class, a wealthy landowner in ancient Rome  
senator, n. a member of the Senate, the patrician lawmaking group in ancient Rome  
citizen, n. a person who belongs to a country and has responsibilities under that country's laws and the army  
plebeian, n. a common person without power in ancient Rome  
republic, n. a kind of government where people elect representatives to rule for them

**"Patricians and Plebeians," Pages 17–19**

power and gave very little to the plebeians. The plebeians could make some laws in their assembly, but the patrician Senate controlled the government. The Senate decided how government money was spent. It also decided who worked for the government and when Rome would make war and peace.



**Page 18**

**Vocabulary**  
assembly, n. a group of people that makes laws  
Senate, n. the patrician lawmaking group in ancient Rome; the most powerful group in the Roman Republic

**To begin, read the entire section aloud for students, stopping when you come to Core Vocabulary. Scaffold understanding as follows:**

**CORE VOCABULARY**—Note in the first line of the section that Lucius's family is described as a patrician family. Ask: What does that mean? (*It means that Lucius's family was rich and important; text says that "his family had great wealth and power" and "lived in a large villa," or house. In the illustration, the family appears to be wearing "fancy clothing."*)

**CORE VOCABULARY**—Ask: When Lucius's grandfather is described as a senator, what does this fact tell us about him? (*He is an important, powerful person who helps make laws in Rome.*)

**CORE VOCABULARY**—In the third paragraph, note the word *citizens*. Review the definition, noting that students are themselves citizens of some country, such as the United States.

**CORE VOCABULARY**—Ask: How do plebeians differ from the patricians? (*They have little power and, often, little wealth.*)

**CORE VOCABULARY**—Explain to students that we now use the term *republic* to describe any type of government that is governed by a group of people, representatives, chosen to act on behalf of the other people.

Each year two patricians were elected to serve as consuls. The consuls commanded the army and made sure laws were carried out. They also led meetings of the Senate.

When Rome went to war, the consuls sometimes chose a dictator to lead the country. The dictator had complete control over Rome. Everyone had to do what he said. The dictator's job was to make sure that Rome was safe and that the army got whatever it needed to win a war. Dictators had great power, but they were allowed to run Rome for only six months.

Lucius and his father arrived in Rome shortly after sunrise. The city was quite empty at that hour. They walked across the Forum in the center of Rome and found a place to sit. They watched as shops opened for the day and Romans crossed the Forum on their way to work.

**Lucius Quinctius Cincinnatus**

"Lucius, this great city was built by people of honor," his father said. "They served Rome because it was their duty. They wanted nothing for themselves. One of the greatest of these people was Lucius Quinctius Cincinnatus (loo'kwɪnts/kuɪnsɪnə'teɪʃəs/ si'nkwɪnts/). You are named for him."

**Page 19**

**Vocabulary**  
consul, n. the most important official in the Roman Republic  
dictator, n. a ruler who has total control over the country  
Forum, n. the area in the center of Rome where government buildings, temples, and other important monuments were built

**SUPPORT**—Note for students the diagram of Roman society on page 18. Use the diagram to review the Core Vocabulary terms *dictator*, *consul*, *senator*, *patrician*, and *plebeian*. Explain that every senator in Rome was a patrician but that not all patricians were senators.

**After reading the text, guide the discussion as follows:**

**INFERENCE**—Did Rome have more patricians or plebeians? How do you know?

- » Rome had more plebeians. The text says, “Only a very few Roman families were patricians.”

**EVALUATIVE**—What were two main differences between patricians and plebeians?

- » The patricians had wealth and power, and the plebeians did not.

**INFERENCE**—How would Lucius’s life be different if he were a plebeian?

- » He would not live in a villa or have a chariot. He and his family would be poor. They would probably not have servants.

**LITERAL**—When might Rome have a dictator?

- » Rome chose to have a dictator temporarily, during times of war.

**INFERENCE**—Why might Romans choose a dictator during a time of war?

- » A dictator can make decisions more quickly and efficiently than a group like the Senate or even a pair of leaders like the consuls. During a war, it’s important to make decisions quickly so that soldiers can be given the best orders and civilians can be protected.

## “Lucius Quinctius Cincinnatus,” Pages 19–21

**Scaffold understanding as follows:**

**SUPPORT**—Call students’ attention to the title of the section, and explain that it is a person’s name. In this case, it is a real person from Roman history. Slowly pronounce the name (/loo\*shee\*us/qwin\*shee\*us/ /sin\*sih\*nae\*tus/). Tell students that they can refer to this person by just his last name, (/sin\*sih\*nae\*tus/), asking them to repeat the name after you.

**Now have students read this section quietly to themselves. Then, ask the following questions:**

**LITERAL**—Who was Cincinnatus?

- » He was a farmer who was chosen to become dictator when Rome was being attacked by enemies.





trapped the entire Roman army in a mountain pass. The army would be destroyed unless help arrived soon.

"Cincinnatus ordered every shop in the city to be closed. He ordered every man and boy in the city to meet in a field with his weapons. Everyone was given a job, and soon they were ready to march. Cincinnatus led this citizen army to the rescue.

"They saved the Roman army. The next day Cincinnatus returned to the Senate. He told the senators that the army had been saved. Then he returned to his farm.

"This great Roman wanted nothing from Rome except a chance to do his duty. That is why I named you Lucius. I want you to remember your duty as a Roman."

Page 21

### LITERAL—What did Cincinnatus do?

- » He set aside his work, put together an army of citizens, and saved the Roman army that had been trapped by enemies.

### INFERENTIAL—Did Cincinnatus think of himself as a hero? Did his life change after he and the army of citizens saved the Roman army?

- » Cincinnatus did not use his success to hold onto power. He returned to his old life on the farm.

### INFERENTIAL—What does it mean “to do his (one’s) duty?”

- » It means to answer the call for help and fulfill your responsibilities.



## CHECK FOR UNDERSTANDING 5 MIN

### Ask students to do one of the following:

- **Turn and Talk**—Ask a partner the answer to the Big Question, “In ancient Rome, what was the difference between patricians and plebeians?”
  - » Key points students should cite include: Patricians were the minority of the population but had the majority of the wealth and power. They controlled the Senate, which controlled the government. Plebeians were the majority of the population but had little wealth and power, although they were represented in the government by an assembly.
- Choose one of the Core Vocabulary words (*chariot, patrician, senator, plebeian, republic, assembly, Senate, consul, dictator, or Forum*), and say a sentence aloud using the word.

To wrap up the lesson, ask several students to share their responses.

## Additional Activities

### The Roman Republic (RI.3.1)

20 MIN

#### Activity Page



AP 3.1

**Materials Needed:** (1) Sufficient copies of The Roman Republic (AP 3.1), found in the Teacher Resources section (page 144), and (2) crayons, highlighters, or colored pencils in at least two different colors.

Ask students to note the shape of the diagram. (*It is a triangle.*) Help students understand the significance of this shape by explaining that the base of the triangle is large, indicating it represents the largest number of people. The top of the triangle is small, meaning it represents the smallest group. At the same time, the diagram shows that the smallest group is at the top—that is, it has power over the groups below.

Have students work with a partner to fill in the diagram on The Roman Republic (AP 3.1) using the information in Chapter 3 of the Student Reader.

After students have completed the diagram, have them create a key: one color for patricians and one color for plebeians. Have them color in the diagram according to the key.

### City Life During the Roman Republic (RI 3.9, W.3.3)

30 MIN

Activity Page



AP 3.2

**Materials Needed:** (1) Sufficient copies of the Life in Rome (AP 3.2) found in the Teacher Resources section (pages 145–146), (2) lined paper, (3) pens or pencils.

Distribute Life in Rome (AP 3.2). Ask volunteers to take turns reading it aloud.

As a group, discuss and complete the Venn diagram. Ask students to compare the following aspects of life: activities during the day, the type of house or residence, type of clothing, language spoken, role of the Roman gods and goddesses, and so on.

As time permits, have students write a one-page letter or diary entry describing a day in the life of a resident of republican Rome. Allow students to create their own persona: male or female, patrician or plebeian. Encourage students to use their imagination to build on details from their reading in the Student Reader and AP 3.2. This assignment could also be completed as homework.

# The Punic Wars

**The Big Question:** What bold attack did Hannibal make in the Second Punic War?

## Primary Focus Objectives

- ✓ Identify Latin as the language spoken by the ancient Romans. **(RI.3.1)**
- ✓ Identify the Punic Wars as struggles between Rome and Carthage. **(RI.3.2)**
- ✓ Identify Hannibal and understand his role in the Punic Wars. **(RI.3.2)**
- ✓ Understand the outcome of the Punic Wars. **(RI.3.2)**
- ✓ Understand the meaning of the following domain-specific vocabulary: *conquer*, *peninsula*, *nation*, *formation*, and *barrier*. **(RI.3.4)**

## What Teachers Need to Know

For background information, download the CKHG Online Resource “About the Punic Wars”:

[www.coreknowledge.org/ckhg-online-resources](http://www.coreknowledge.org/ckhg-online-resources)

## Materials Needed

Activity Page



AP 1.3

Display copy of Map of the Mediterranean Region and/or student copies of AP 1.3, found in the Teacher Resources section (page 139).

## Core Vocabulary (Student Reader page numbers listed below)

**conquer, v.** to win control of a land and its people by attacking an enemy or fighting a war **(22)**

*Example:* Rome used its strong army to conquer its neighbors.

*Variation(s):* conquered

**peninsula, n.** a piece of land sticking out into a body of water, so that it is almost surrounded by water **(22)**

*Example:* Rome is located near the center of the Italian peninsula, which looks like a boot in the Mediterranean Sea.

**nation, n.** the land and people who live under the authority of a government and its laws; a country **(22)**

*Example:* Ancient Carthage stood where the modern nation of Tunisia now exists on the coast of North Africa.

*Variation(s):* nations

**formation, n.** an orderly arrangement, such as in rows or a line (24)

*Example:* Fighting in formation helped the Roman army fight in a more orderly and more effective way.

**barrier, n.** something that is in the way (26)

*Example:* The steep mountains called the Alps formed a barrier between France and Italy, making it difficult to travel between the two regions.

*Variation(s):* barriers

## THE CORE LESSON 25 MIN



### Introduce “The Punic Wars”

5 MIN

Display the Map of the Mediterranean Region and/or have students refer to their own individual copies of AP 1.3 from Chapter 1. Point out the locations of Carthage on the continent of Africa and Rome on the continent of Europe. Note that both of these places were cities but that both controlled large areas. As a result, *Rome* and *Carthage* refer both to cities and to the larger empires they controlled. Looking at the map, ask students the fastest way to get from Carthage to Rome. Remind them that the fastest way will be the most direct way (i.e., a straight line from Carthage to Rome). So the fastest way would be to cross the Mediterranean Sea. Tell students that in this chapter, they will read about a series of wars between Rome and Carthage.

Call students’ attention to the Big Question. Explain that Hannibal was the leader of Carthage’s army. Ask what it means to be bold. Invite students to give examples of bold behavior. Suggest students keep these ideas in mind as they read about Hannibal.

### Guided Reading Supports for “The Punic Wars”

20 MIN

When you or a student reads aloud, **always** prompt students to follow along. By following along, students may acquire a greater understanding of the content. Remember to provide discussion opportunities.

#### “The Roman Army,” Pages 22–23

**Scaffold understanding as follows:**

**CORE VOCABULARY**—Invite a volunteer to read the section “The Roman Army.” Point out the vocabulary word *conquered*. Ask students to identify the context clues that help them define the word.

**Chapter 4**  
**The Punic Wars**

**The Roman Army** In its early days, Rome was a small city with a small army. This army was made up of Roman citizens and included both patricians and plebeians. It was a great honor to be in the army and defend the city of Rome.

**The Big Question**  
What bold attack did Hannibal make in the Second Punic War?

**Vocabulary**  
**conquer** v. to win control of a land and its people by attacking an enemy or fighting a war

The Romans fought some of their neighbors. When the Romans **conquered** an enemy, they took control of the land and people living there. In time, the Roman army became large and powerful. By the year 265 BCE, the army had conquered most of the Italian **peninsula**.

**peninsula** n. a piece of land sticking out into a body of water, on three sides, surrounded by water

In 264 BCE the Romans went to war against Carthage. Carthage was a powerful nation located across the Mediterranean Sea on the coast of North Africa. Today, the city of Tunis stands where Carthage once stood.

**Page 22**



**Page 23**

**CORE VOCABULARY**—Note the word *peninsula* in the second paragraph of “The Roman Army.” Explain that this is a geographic term that describes many areas on the globe. Have students refer to AP 1.3 as you point to the boot shape of Italy, explaining that a peninsula is a strip of land that is nearly, but not completely, surrounded by water. Another example students might notice on the map is that Spain is on a peninsula.

**Have students read the entire text silently to themselves. When students have finished, ask the following questions:**

**LITERAL**—How did the Roman army change over time?

- » At first it was a small army. Over time, it became large and powerful and able to conquer the entire Italian peninsula.

**INFERENTIAL**—Why did the Roman army conquer the Italian peninsula first?

- » It conquered the Italian peninsula first because Rome was located on the Italian peninsula. The army first conquered Rome’s neighbors and then moved outward until it controlled the entire peninsula.

**“The Punic Wars” and “The First Punic War,” Page 24**

**The Punic Wars**

These wars against the Carthaginians (/kɑrˈθuːʒiˈneɪʃən/) are called the Punic (/puːˈniːk/) Wars. The name comes from Latin, the language spoken by the Romans. The Latin word Punicus means Carthaginian. So, a Punic War is a war between Rome and Carthage. Since Rome and Carthage went to war three times, these wars are called the First, Second, and Third Punic Wars. They were fought between 264 and 146 BCE.

**The First Punic War**

The First Punic War was different from any war the Romans had fought before. Carthage was a rich nation with a large navy. When the First Punic War began, Carthage had five hundred fighting ships. Rome had no navy at all.

The Romans were determined to win. They built warships and learned to fight at sea. They learned to fight in formation. They trained tens of thousands of sailors to man their warships. They fought the Carthaginians for twenty-three long years. When the First Punic War ended in 241 BCE, the Romans had won.

**Vocabulary**  
**formation** n. an orderly arrangement, such as in rows or a line

**Hannibal**

At the end of the First Punic War, a young Carthaginian boy named Hannibal wanted for his father to return from battle. His father was a Carthaginian army. Hannibal wanted to

**Page 24**

**Scaffold understanding as follows:**

**CORE VOCABULARY**—Review the vocabulary terms *nation* and *formation*. Point out the example of a military formation in the illustration on page 25.

Also point out and pronounce the word *Carthaginians*, explaining that this is what people who lived in Carthage were called, as well as the word *Punic*.

**Have students read the sections “The Punic Wars” and “The First Punic War” aloud to a partner. Encourage each partner to read one section. After students have finished reading, ask the following questions:**

**LITERAL**—Where did the name *Punic Wars* come from?

- » The name Punic Wars came from the Latin word Punicus, which means Carthaginian.

**LITERAL**—How many Punic Wars were there?

- » Three

**LITERAL**—What happened in the First Punic War?

- » The Romans learned to fight at sea. After three years of fighting, the Romans finally won.

**EVALUATIVE**—Why were the Romans at a disadvantage when the First Punic War began?

- » Carthage had a large, powerful navy. Rome had no navy at all.

**EVALUATIVE**—How did the First Punic War make Rome stronger?

- » Rome built a navy and learned to fight at sea. The Romans went from having no navy to having a navy strong enough to defeat Carthage's large, powerful naval force.

## "Hannibal," Pages 24–25

be a soldier like his father. More than anything, he wanted to fight against the Romans.



When Hannibal's father returned, he became commander of Carthage's army. He then conquered the rich lands along the northwest coast of the Mediterranean. Today this area is called Spain.

When he was nine years old, Hannibal went to Spain with his father and the army. Hannibal grew to be an excellent soldier, like his father. When he was twenty-six years old, Hannibal took command of the Carthaginian army.

Hannibal was a great general. He was brave and clever in battle. He treated his men fairly and earned their respect and loyalty.

**The Second Punic War**

Hannibal still wanted to fight Rome. In 219 BCE he attacked a town that was friendly with Rome. This attack started the Second Punic War.

Next, Hannibal decided to march his army from Spain to Italy. This meant crossing wide rivers and the tall snow-covered mountains known as the Alps.

It would be hard for the soldiers to cross these rivers and mountains. Hannibal had to get thousands of horses and

**Page 25**

Ask students to read the section "Hannibal" to themselves. After all students finish reading, ask the following question:

**LITERAL**—Who was Hannibal?

- » He was the son of a commander in the Carthaginian army. He became a soldier and eventually took command of Carthage's army.

## "The Second Punic War" and "The Third Punic War," Pages 25–27



Hannibal's route from Spain to the lands of Rome

dozens of elephants across these barriers. The Carthaginian army used African elephants in battle. Most of their enemies in Europe had never seen elephants and were terrified by them.

The Romans thought that no army would ever be able to cross the rugged Alps. They were wrong. The Carthaginians made it over the Alps and onto the Italian peninsula. The crossing took fifteen hard days, and Hannibal lost almost half his men.

Hannibal fought the Romans on the Italian peninsula for the next sixteen years. He won great battles, but Romans would not give up. Eventually, the Romans sent an army to attack Carthage. Hannibal rushed home. Outside Carthage, Hannibal met a Roman army led by General Scipio Africanus. Scipio defeated Hannibal's army. The Carthage surrendered, but Hannibal

**Page 26**

Read both sections aloud. Scaffold understanding as follows:

**SUPPORT**—After reading "The Second Punic War," refer students to the map on page 26. Then, reread the first two sentences of the third paragraph aloud: "It would be hard to cross these rivers and mountains. Hannibal also had to get thousands of horses and dozens of elephants across these **barriers**."

**CORE VOCABULARY**—Review the vocabulary term *barrier*. Referring to the map, ask students to discuss how mountains form a geographic barrier.

Finish reading page 27 aloud to students, referring to the illustration and caption when encountered. Then ask the following questions:

**LITERAL**—Why did the Romans feel protected by the Alps?

- » They thought no army would be able to cross them.

**EVALUATIVE**—Did Hannibal make the right decision by leading his army across the Alps?

- » Students might say yes, because he took the Romans by surprise, or no, because Hannibal lost almost half his army but still couldn't defeat the Romans—even after sixteen years of fighting.



Roman legions feared the elephants when they first saw them.

continued to fight. He moved from place to place, staying away from the Romans. When the Romans finally trapped him, Hannibal refused to surrender. Instead, he killed himself.

**The Third Punic War**

After the Second Punic War, Rome and Carthage were at peace for more than fifty years. Then in 149 BCE, the Third Punic War began. The Romans sent a huge army to Africa. The fighting lasted only three years. In the end, the Romans destroyed the city of Carthage. The Carthaginians who were not killed were enslaved.

**Page 27**

**LITERAL**—What event led to the end of the Second Punic War?

- » A Roman army attacked Carthage. Roman General Scipio Africanus defeated Hannibal outside of Carthage.

**INFERENTIAL**—Knowing that the city of Carthage surrendered but that Hannibal did not, why do you think he refused to surrender?

- » Possible answers: He hated the Romans. He was too proud to surrender. He still thought he could win.

**LITERAL**—What happened in the Third Punic War?

- » The Romans sent an army to Africa. After three years of fighting, they won and destroyed the city of Carthage.

**INFERENTIAL**—Why was the Third Punic War the *last* Punic War?

- » There was no enemy left to fight. The Romans destroyed the city of Carthage and enslaved the Carthaginians who survived.

## Timeline

---

- Show students the Chapter 4 Timeline Image Card. Read and discuss the caption, making particular note of any dates.
- Review and discuss the Big Question: “What bold attack did Hannibal make in the Second Punic War?”
- Post the image card as the third image on the left of the Timeline, under the date referencing 300–101 *BCE*; refer to the illustration in the Unit 2 Introduction for further guidance on the placement of each image card to the Timeline.



### CHECK FOR UNDERSTANDING 5 MIN

**Ask students to do one of the following:**

- **Turn and Talk**—Ask a partner the answer to the Big Question, “What bold attack did Hannibal make in the Second Punic War?”
  - » Key points students should cite include: Hannibal marched his army, including its elephants, across the Alps, a steep mountain barrier that the Romans thought no army could or would ever cross. This allowed Hannibal to strike at the Roman heartland.
- Choose one of the Core Vocabulary words (*conquer, peninsula, nation, formation, or barrier*), and say a sentence aloud using the word.

To wrap up the lesson, ask several students to share their responses.

## Additional Activities

### Domain Vocabulary: Chapters 1–4 (L.3.6)

30 MIN

Activity Page



AP 4.1

**Materials Needed:** Sufficient copies of Domain Vocabulary: Chapters 1–4 (AP 4.1), found in the Teacher Resources section (page 147).

Distribute Domain Vocabulary: Chapters 1–4 (AP 4.1) found in the Teacher Resources section (page 147), and direct students to complete the sentences by choosing the correct word in each set of parentheses. Encourage students to use the glossary in their Student Reader if they need help.

You may choose to have students work in pairs to complete AP 4.1 or may assign it for homework.



### The Punic Wars (SL.3.1)

30 MIN

Use this link to download the CKHG Online Resources for this unit, where specific links to videos about Hannibal may be found:

[www.coreknowledge.org/ckhg-online-resources](http://www.coreknowledge.org/ckhg-online-resources)

Show students the videos. Each video is approximately four minutes long.

1. *Hannibal's War Elephants*
2. *Hannibal Ambushes the Romans*

Encourage students to take notes on the videos.

After students have watched the videos, discuss them with the class. Begin by getting students' impressions of the videos. What did they find interesting? What surprised them?

Then guide the discussion toward the chapter's Big Question, "What bold attack did Hannibal make in the Second Punic War?", and toward Hannibal as a bold, skilled military leader. What details in the videos support these conclusions?

Ask students if, based on these videos, they are surprised that Hannibal and the Carthaginians lost the Second Punic War. Encourage them to support their opinions with details from the videos and Chapter 4 of the Student Reader.

**Note:** Please preview these and other videos about Hannibal and the Punic Wars on the History Channel site if you wish to include them in the activity. Some contain information that students might find disturbing. The video *Hannibal the Child Soldier*, for example, discusses the sacrifice of five hundred Carthaginian children who were burned to death.



# Julius Caesar

**The Big Question:** Why did some Romans think Julius Caesar was a hero?

## Primary Focus Objectives

---

- ✓ Understand how Roman armies increased the area under Rome’s control. **(RI.3.2)**
- ✓ Recognize that the Greeks influenced Roman culture. **(RI.3.2)**
- ✓ Explain why some wealthy people in the Roman Republic became richer while many poor people became poorer. **(RI.3.2)**
- ✓ Identify Julius Caesar and describe his role in adding more provinces to Rome’s control. **(RI.3.2)**
- ✓ Understand the meaning of the following domain-specific vocabulary: *province, governor, tax, border, and civil war*. **(RI.3.4)**

## What Teachers Need to Know

---

For background information, download the CKHG Online Resource “About Julius Caesar”:

[www.coreknowledge.org/ckhg-online-resources](http://www.coreknowledge.org/ckhg-online-resources)

This chapter discusses the disenfranchisement of Roman farmers. The Student Reader gives a simplified explanation of what happened. During this era, smaller landholders—the peasant farmers who tended to form the core of the Roman army—were losing their farms to the large estates of the wealthy. Sometimes the farmers/soldiers were away at war for extended periods of time (or died on campaign). Once landless, the peasant farmers tended to drift to the cities, especially to Rome, swelling the urban population. So the estates of the wealthy became larger and larger, worked by enslaved people, while the smaller farmers lost their lands and often moved to the city.

## Core Vocabulary **(Student Reader page numbers listed below)**

---

**province, n.** an area or region; when an area was conquered by Rome, it became a province under Roman control **(28)**

*Example:* The Roman army added more and more provinces that were ruled by Rome.

*Variation(s):* provinces

**governor, n.** the leader of the government in a province **(28)**

*Example:* The Roman Senate appointed a governor to rule a province of the empire.

*Variation(s):* governors

**tax, n.** money that people pay to the government (28)

*Example:* Conquered peoples had to pay a tax to the Roman government.

*Variation(s):* taxes

**border, n.** an imaginary line that marks the edge of a country or other piece of land (32)

*Example:* The Rubicon River marked the border between Italy and the Roman province of Gaul.

*Variation(s):* borders

**civil war, n.** a war between people who live in the same country (33)

*Example:* When Julius Caesar disobeyed the Senate's orders and brought his army into Italy, he started a civil war.

*Variation(s):* civil wars

## THE CORE LESSON 25 MIN

### Introduce "Julius Caesar"

5 MIN

Explain that in this chapter, students will read about one of the most famous and popular leaders in Roman history: Julius Caesar. Introduce the Big Question. Ask students what qualities a leader must possess to be regarded as a hero. List these qualities on the board or chart paper. Encourage students to keep the qualities on this list in mind as they read about Julius Caesar.

### Guided Reading Supports for "Julius Caesar"

20 MIN

When you or a student reads aloud, **always** prompt students to follow along. By following along, students may acquire a greater understanding of the content. Remember to provide discussion opportunities.

### "The Roman Army," Pages 28–29

Ask a student volunteer to read the section "The Roman Army" aloud.

**Chapter 5**  
**Julius Caesar**

**The Roman Army** The Romans were great conquerors. They had large, well-trained armies. Their navy ruled the seas. After the Romans defeated an enemy, the captured land became part of Rome.

**The Big Question**  
Why did some Romans think Julius Caesar was a hero?

**Vocabulary**  
These lands were called **provinces**. The Roman Senate sent a **governor** to each province. The governor made sure the province paid **taxes** to Rome. The Romans usually let the conquered people keep their laws and customs. Sometimes they even made the conquered people citizens of Rome.

**provinces**, n. an area or region where an area was conquered by Rome. It became a province under Roman control.

**governor**, n. the leader of the government in a province.

**tax**, n. money that people pay to the government.

**Page 28**

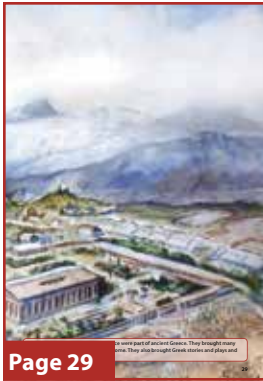

**After finishing this section, review the meanings of *province, governor, and tax.***

Ask students to **TURN and TALK** to a partner and give a one-sentence summary explaining how Rome built its empire. Ask one to two pairs to share.

**“The Impact of Ancient Greece,” Page 30**

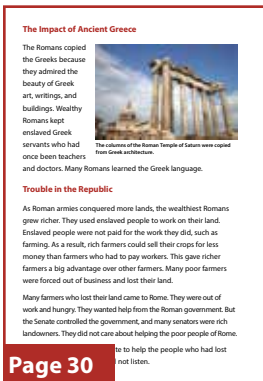

**Invite a volunteer to read the section aloud. After the volunteer reads the section, discuss the illustrations on pages 28–30, and ask the following questions:**

**LITERAL**—How do we know the Romans admired the Greeks?

- » The Romans copied Greek art and writing and building styles. They also copied Greek ways of living.

**EVALUATIVE**—How does the photo of the Temple of Saturn support the idea that the Romans admired the Greeks?

- » It shows a Roman temple that was built using a Greek building style similar to the Parthenon, depicted on page 29.

**Note:** Students using a curriculum based on the *Core Knowledge® Sequence* will have already studied about ancient Greece and the Parthenon in Grade 2.

**“Trouble in the Republic,” Pages 30–31**

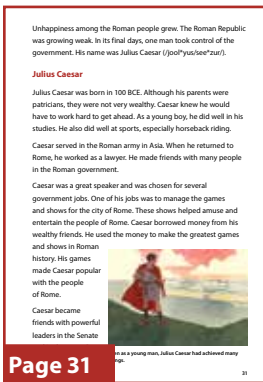

**Have students read the section to themselves. After students have finished reading, ask the following questions:**

**LITERAL**—What happened to many poor farmers in Rome?

- » They were forced out of business and lost their farms to rich farmers. They came to Rome looking for work and help from the Roman government.

**EVALUATIVE**—Why were many of the Roman people unhappy?

- » The Roman Senate refused to help the poor farmers who lost their land.

## “Julius Caesar,” Pages 31–32

Pompey (/pɑːmˈpeɪ/), Rome's most famous general. Caesar also had enemies in the Senate, especially among the wealthy landowners.

Caesar was elected consul in 59 BCE. Then he became governor of two provinces next to an area called Gaul. Today we know this area as southern France and northern Italy.

Caesar led a large Roman army into Gaul. The Gauls were fierce warriors, but Caesar was an excellent general. His soldiers loved him. Caesar won many victories. His conquests in the Gallic Wars of 58–51 BCE made him a hero to many Romans.

**Crossing the Rubicon**

Caesar's old friend Pompey became jealous of Caesar. He watched Caesar grow more powerful with each victory. Soon Pompey was no longer Rome's most famous general. Caesar was.

Pompey joined Caesar's enemies in the Senate. They hated and feared Caesar. They thought he was too popular with the Roman people. His army had grown too powerful. The Senate ordered Caesar to give up his army and return to Rome.

Caesar led his army to the Rubicon, the border between Gaul and Italy.

**Page 32**

**Vocabulary**  
border: an imaginary line that marks the edge of a country or other piece of land.



Read this section aloud, pausing to discuss each of the paragraphs to ensure student understanding. After you have finished reading, guide the discussion as follows:

**LITERAL**—What kind of person was Julius Caesar?

- » He was a patrician, but not rich. He was a hard worker and a good speaker. He knew how to make friends.

**EVALUATIVE**—How did Julius Caesar show he was a good leader?

- » He won popularity by putting on the greatest games Rome had ever seen. He was an excellent general who won the love of his soldiers and whose victories made him a hero to the Roman people.

## “Crossing the Rubicon,” and “Civil War,” Pages 32–33

and Italy, Caesar stopped and thought about what to do next.

If his army crossed the Rubicon, he would be at war with Rome. But if he left his army in Gaul, he would have no protection against his enemies. They would probably kill him. Caesar decided to fight. He led his army across the river and started a civil war.

**Civil War**

The war did not go well for Caesar's enemies. Caesar drove them out of Italy into Spain and finally to Greece. There, Caesar won a clear victory. After he won, Caesar forgave the senators who fought against him.

Caesar's old friend Pompey escaped. He went to Egypt, where the king had him killed. For the king, this proved to be a terrible mistake.

**Page 33**

**Vocabulary**  
civil war: a war between people who live in the same country.



Have students read the sections with a partner. After students have finished reading, ask the following questions:

**EVALUATIVE**—Why were Pompey and others in the Senate jealous of Caesar?

- » He was more popular than they were.

**LITERAL**—How did Caesar start the civil war?

- » He disobeyed the Senate's orders and brought his army across the Rubicon River into Italy.

**LITERAL**—What happened in the civil war?

- » Caesar drove his enemies out of Italy into Spain and finally to Greece, where he then won a clear victory. His old friend Pompey escaped Egypt but was killed by Egypt's king.

## Timeline

- Show students the Chapter 5 Timeline Image Cards. Read and discuss the captions, making particular note of any dates.
- Review and discuss the Big Question, “Why did some Romans think Julius Caesar was a hero?”
- Post the image cards as the fourth and fifth images on the Timeline, under the date referencing 100 BCE–99 CE; refer to the illustration in the Unit 2 Introduction for further guidance on the placement of each image card to the Timeline.



## CHECK FOR UNDERSTANDING 5 MIN

**Ask students to do one of the following:**

- **Turn and Talk**—Ask a partner the answer to the Big Question, “Why did some Romans think Julius Caesar was a hero?”
  - » Caesar won victories in Gaul that made him a hero.
- Choose one of the Core Vocabulary words (*province, governor, tax, border, or civil war*), and say a sentence aloud using the word.

To wrap up the lesson, ask several students to share their responses.

## Additional Activities



### What Did Caesar Look Like? (SL.3.3)

30 MIN

**Materials Needed:** Images of busts of Julius Caesar.

Ask students what they think Julius Caesar might have looked like based on what they read and saw in their Student Readers. Tell students that most images that we have of Caesar were created hundreds of years or more after his death. Discuss with students the challenges that presents.

Display two or three different images of Julius Caesar. Use this link to download the CKHG Online Resources for this unit, where the specific links for the images of busts may be found:

[www.coreknowledge.org/ckhg-online-resources](http://www.coreknowledge.org/ckhg-online-resources)

#### **Bust by Andrea di Pietro di Marco Ferrucci at the Metropolitan Museum of Art**

This sculpture from the early 1500s shows an idealized Julius Caesar—still young and vigorous-looking. Yet the tilt of his head and expression make him seem very human. He is wearing armor that has the image of Medusa, a monster of Roman myth who turned anyone who gazed upon her to stone.

#### **Marble Head at the British Museum**

This bust was probably created in the 1700s, hundreds of years after Caesar’s death. Note for students the effect of Julius Caesar’s gaze, which is off to the left. Note also the sculpture’s presentation of his hair, which suggests he was concerned about his appearance and baldness.

#### **The Chiaramonti Caesar at the Vatican Museums**

This bust was made shortly after Caesar’s murder. Note for students that this

bust presents a more idealized presentation of Julius Caesar.

**Roman Emperor (Julius Caesar) by Mino da Fiesole at the Museum of Fine Arts, Boston**

This sculpture dates from the 1400s, and it shows Caesar with a laurel wreath—a Roman symbol of victory or achievement—and wearing military garb. The shoulders suggest a vigorous motion, as Caesar is striding forward.

After students have viewed all of the sculptures, have them compare the images. What features do they all have in common? (*Possible answer: the nose and basic facial structure seem the same in all of the sculptures.*) What conclusion can we draw from that? (*The artists used the same source, or that's what Caesar really looked like.*) How do they differ? (*The hair lengths and styles vary, with some having more hair than others. Some of the sculptures stress the strength and vigor of Julius Caesar more than others.*) What conclusions can we draw from that? (*At different times, different artists have wanted to stress different qualities of Caesar. For example, some sought a more heroic and appealing presentation, while others tried to make him seem more human.*)

Ask volunteers to share which bust they liked the best and why and which bust most closely resembles their own image of Caesar.



**Julius Caesar Campaign Posters (RI.3.2)**

**30 MIN**

**Materials Needed:** (1) Poster board or chart paper, (2) markers, crayons, or colored pencils.

Have students work in pairs to create a campaign poster for Julius Caesar. Tell students to imagine that they are helping Caesar run for the job of consul. They should create a poster that would encourage assembly voters to vote for Caesar.

Questions they should consider: Why would Caesar make a good consul? Why should people vote for him?

## CHAPTER 6

# Cleopatra, Queen of Egypt

**The Big Question:** What did Julius Caesar do in order to protect Cleopatra?

### Primary Focus Objectives

- ✓ Describe how Julius Caesar met Cleopatra. (RI.3.2)
- ✓ Identify several examples that indicate that Cleopatra wanted to be a good ruler. (RI.3.2)
- ✓ Understand the meaning of the following domain-specific vocabulary: *barge* and *descendant*. (RI.3.4)

### Core Vocabulary (Student Reader page numbers listed below)

**barge, n.** a boat with a flat bottom, usually used for carrying goods (36)

*Example:* Legend says that Caesar traveled down the Nile River on a barge with Cleopatra.

*Variation(s):* barges

**descendant, n.** someone who is related to a person or group of people who lived in the past (37)

*Example:* Cleopatra believed she was a descendant of one of Alexander the Great's best generals.

*Variation(s):* descendants

### THE CORE LESSON 25 MIN

#### Introduce “Cleopatra, Queen of Egypt”

5 MIN

Remind students that at the end of the last lesson, they learned that the king of Egypt had Pompey killed—and that this was a terrible mistake. Ask students why they think this might have been a mistake. Tell students that in this chapter they will read about what happened in Egypt after Pompey had been killed.

Draw students' attention to the Big Question. As they read, ask them to pay particular attention to what Julius Caesar had to do in order to protect Cleopatra.

When you or a student reads aloud, **always** prompt students to follow along. By following along, students may acquire a greater understanding of the content. Remember to provide discussion opportunities.

## “Arrival in Egypt,” Page 34

Read the section aloud. Then ask students the following questions:

**LITERAL**—How did Caesar react when he found out Pompey had been killed? Why?

- » He was angry. Because Pompey was a Roman general, Caesar saw Pompey’s murder as an insult to Rome.

**INFERENTIAL**—How might Caesar have felt about the Egyptian king?

- » Caesar might have felt the king could not be trusted. He might also have felt the king was not a capable one or a respectful one.

**Chapter 6**  
**Cleopatra, Queen of Egypt**

**Arrival in Egypt** In 48 BCE Julius Caesar sailed along the Nile River and arrived in Alexandria, Egypt, with a small group of soldiers. Caesar was looking for Pompey. He went to the king’s palace. There he learned that Pompey was dead.

**The Big Question**  
What did Julius Caesar do in order to protect Cleopatra?

The king of Egypt had trusted his advisers. They had promised him that Caesar would be happy that Pompey was dead. They were wrong. Pompey was a Roman general. Caesar saw Pompey’s murder as an insult to Rome.

**Cleopatra**

While Caesar was still a guest at the palace, a servant entered carrying a large, rolled-up rug. Caesar watched as the rug was unrolled. Cleopatra (klee-oh-pah-trah), the queen of Egypt, was hiding inside. Cleopatra begged Caesar to protect her from her brother, the king. She said the king and his advisers were planning to murder her. It took a little while for Caesar to reply. He stared at Cleopatra and listened to her voice. He would certainly protect her. He wanted to see if she was really who she said she was. Cleopatra stayed with Caesar.

**Page 34**

## “Cleopatra,” Pages 34–37

Call students’ attention to the illustration on page 35, telling them that they are about to read about a woman named Cleopatra who was the queen of Egypt. Ask students to describe how Cleopatra is depicted. Invite volunteers to take turns reading parts of the section.

After students have read the section, guide the discussion with the following questions:

**LITERAL**—How did Caesar meet Cleopatra?

- » He traveled to Egypt to look for Pompey, but he discovered that the king had killed Pompey. While Caesar was at the king’s palace visiting, a rolled-up rug was brought out. When the rug was unrolled, Caesar saw Cleopatra hiding inside.

**LITERAL**—Why did Cleopatra ask for Caesar’s protection?

- » Her brother, the king, wanted to kill her.

**LITERAL**—How did Caesar protect Cleopatra?

- » He ordered the Roman army to come to Alexandria. He killed the king’s chief adviser and defeated the Egyptian army.



The king and his advisers were angry that Cleopatra had outsmarted them. They were also angry that Caesar agreed to protect Cleopatra. They ordered the Egyptian army to surround the palace. They thought this would make Caesar change his mind. Once again, they were wrong.

Caesar ordered the Roman army in nearby Syria to march on Alexandria. Caesar killed the king’s chief adviser. The Egyptian king fled from his own palace. When the Roman army arrived, Caesar took command. He easily defeated the Egyptian army. The king of Egypt died in the battle.

Cleopatra was very grateful to Caesar. She asked him to travel through Egypt with her. According to legend, they sailed up the Nile River on her royal barge. Caesar learned a lot about Cleopatra on this journey.

**Vocabulary**  
Barge, n. a boat with a flat bottom, usually used for carrying goods.

Cleopatra was actually Greek, not Egyptian. Almost three hundred years earlier, the Greek king Alexander the Great had conquered

**Page 36**



Egypt and built the great city of Alexandria. Cleopatra was a descendant of one of Alexander's Greek generals. Cleopatra studied hard to be a good ruler. She learned about other countries from people who came to study in Alexandria's great library. She also learned to speak many languages. She was the only one in the history of her royal family who could speak to the Egyptian people in their own language. Caesar came to trust Cleopatra. He did not want to make Egypt a Roman province. He wanted Cleopatra to remain queen of Egypt. Caesar also fell in love with Cleopatra. Caesar, however, was a busy man. He left Egypt to finish the war against Pompey's remaining army.

**Vocabulary**  
*descendant, n.*  
 someone who is related to a person or group of people who lived in the past



Page 37

**INFERENTIAL**—Knowing that in royal families, brothers and sisters and even parents and children may often compete with one another for power, why do you think the king of Egypt might have wanted to kill his sister, Cleopatra?

» She was a threat to his power.

**EVALUATIVE**—What evidence is there in the text that Cleopatra wanted to be a good ruler? What qualities helped Cleopatra to succeed?

» The text says she studied to be a good ruler. Even though she was Greek, she learned to speak to the Egyptians in their own language.



## CHECK FOR UNDERSTANDING 5 MIN

**Ask students to do one of the following:**

- **Turn and Talk**—Ask a partner the answer to the Big Question, “What did Julius Caesar do in order to protect Cleopatra?”
  - » Key points students should cite include: he killed the king’s chief adviser, called in the Roman army from Syria, and defeated the Egyptian army in battle, killing the Egyptian king.
- Choose one of the Core Vocabulary words (*barge* or *descendant*), and say a sentence aloud using the word.

To wrap up the lesson, ask several students to share their responses.

## Additional Activities



### Cleopatra Diary (W.3.3)

30 MIN

Have students assume the role of Caesar, Cleopatra, or Cleopatra’s brother, the king, and write a series of diary entries describing the events discussed in Chapter 6 from that person’s perspective. Encourage students to incorporate details from the illustrations in the Student Reader and from their imaginations in their diary entries.



## Cleopatra's Egypt

30 MIN

### Activity Pages



AP 1.1

AP 1.3

AP 6.1

**Materials Needed:** (1) Sufficient copies of Cleopatra's Egypt (AP 6.1), found in the Teacher Resources section (pages 148–149), (2) colored pencils, (3) access to print or online atlases, the World Map (AP 1.1), and the Map of the Mediterranean Region (AP 1.3).

Distribute both pages of Cleopatra's Egypt (AP 6.1). Have students complete the activity referring to print or online atlases, as well as to AP 1.1 and AP 1.3.

Students might work individually or in pairs. You may also choose to assign these activity pages as homework.

# Julius Caesar Dies

**The Big Question:** What were the reasons behind the actions taken against Julius Caesar and Marc Antony?

## Primary Focus Objectives

- ✓ State the meaning of “*Veni, vidi, vici.*” (RI.3.4)
- ✓ Describe the circumstances under which Julius Caesar became a dictator. (RI.3.3)
- ✓ Describe why Julius Caesar was assassinated. (RI.3.2, RI.3.3)
- ✓ Describe the civil war that followed Caesar’s death. (RI.3.3)
- ✓ Identify Brutus, Marc Antony, and Octavian and their roles in Caesar’s assassination and its aftermath. (RI.3.2)
- ✓ Understand the meaning of the following domain-specific vocabulary: *assassinate, toga, empire, foreigner, supplies, and noble.* (RI.3.4)

## What Teachers Need to Know

For background information, download the CKHG Online Resource “About Julius Caesar and After Caesar”:

[www.coreknowledge.org/ckhg-online-resources](http://www.coreknowledge.org/ckhg-online-resources)

## Materials Needed

Activity Page



AP 1.3

Display copy of the Map of the Mediterranean Region (AP 1.3), found in the Teacher Resources section (page 139).

## Core Vocabulary (Student Reader page numbers listed below)

**assassinate, v.** to kill a ruler or member of the government (40)

*Example:* Members of the Senate wanted to assassinate Julius Caesar because they thought he was trying to become a king.

*Variation(s):* assassinates, assassinated, assassination

**toga, n.** a robe-like piece of clothing worn in ancient Rome. (40)

*Example:* The member of the Roman Senate wore a toga with a purple border.

*Variation(s):* togas

**empire, n.** a group of countries or territories under the control of one government or one ruler (42)

*Example:* The Roman Empire included parts of Europe, Asia, and Africa.

*Variation(s):* empires

**foreigner, n.** someone from another country (42)

*Example:* The Egyptian queen Cleopatra was a foreigner in Rome.

*Variation(s):* foreign, foreigners

**supplies, n.** food and other goods that are needed for a certain purpose (43)

*Example:* Marc Antony's wife sent supplies to help her husband in his fight against Octavian.

**noble, adj.** belonging to the highest social class (43)

*Example:* Marc Antony married Octavian's sister Octavia because she was a noble Roman woman.

## THE CORE LESSON 25 MIN

### Introduce "Julius Caesar Dies"

5 MIN

Remind students that while Julius Caesar was a popular leader with the ordinary people of Rome, he had enemies in the Senate. Review why some senators were jealous of Caesar, and remind students that Caesar had defeated his enemies in a civil war. Explain that even though Caesar forgave his enemies after beating them, his enemies did not necessarily change their feelings about Caesar.

Draw students' attention to the Big Question. Ask students what happened to Caesar and to Marc Antony, the Roman ruler who followed him, and why.

### Guided Reading Supports for "Julius Caesar Dies"

20 MIN

When you or a student reads aloud, **always** prompt students to follow along. By following along, students may acquire a greater understanding of the content. Remember to provide discussion opportunities.

## “More Conquests,” Pages 38–40

**Chapter 7**  
**Julius Caesar Dies**

**More conquests** Julius Caesar continued to conquer. When he left Egypt, he led his army to Asia Minor, the home of modern-day Turkey. There, Caesar once again showed he was a great general.

**The Big Question**  
What were the reasons behind the actions taken against Julius Caesar and Marc Antony?

Caesar sent a message to the Senate about his latest conquest. It was only three Latin words: “Veni, vidi, vici!” (“wee-nee-vee-oh-vee-see-see”) The words mean, “I came, I saw, I conquered.”

Next, Caesar went to North Africa and won another victory. Then, he went to Spain and defeated armies led by Pompey’s sons. Finally, he returned to Rome. There he became dictator—for life. Caesar was now the most powerful man in the world.

Caesar changed the Roman government. He lowered taxes, appointed new senators, and replaced several greedy governors in the provinces. He gave land to Roman soldiers and food to the poor.

Caesar’s enemies in the Senate did not like these changes. They thought Caesar was acting like a king and had too much power.

**Page 38**



**Page 39**

Caesar invited Cleopatra to Rome to celebrate his victories. He gave her gifts and placed a statue of her in a temple.

Caesar’s enemies worried that Caesar would marry Cleopatra and move the government to Alexandria. They also disliked the way Caesar had ended the republic and set himself up as a dictator for life. They decided to assassinate Caesar.

**The Assassination**

The Romans called March 15 the Ides of March. On that day in 44 BCE, several of Caesar’s enemies entered the Senate with knives hidden under their togas.

When Caesar entered the Senate, his enemies stabbed him. One of the attackers was Brutus (bruh’toos), a man Caesar had forgiven after the civil war. Caesar thought Brutus was his friend. Surprised that Brutus had joined his enemies, Caesar’s last words were, “Et tu, Brute!” (et-too’bruh’tooy). This means “You too, Brutus!”

**Vocabulary**  
assassinate, v. to kill a ruler or member of the government  
toga, n. a robe-like piece of clothing worn in ancient Rome



**Page 40**

Read aloud the first three paragraphs of the section “More Conquests” on page 38. Display the Map of the Mediterranean Region (AP 1.3), and ask the following questions:

**LITERAL**—Can you locate each of Caesar’s conquests described in the text on the map? (Ask volunteers to take turns finding the locations.)

**LITERAL**—What did Caesar say about his victories in Asia Minor, and what does the phrase mean?

» He said, “*Veni, vidi, vici*,” which means, “I came, I saw, I conquered.”

**CHALLENGE**—What language is the phrase *Veni, vidi, vici*?

» These are Latin words.

**EVALUATIVE**—Why would Caesar want to conquer so many lands?

» By conquering lands, Caesar could increase the amount of money—taxes—coming into Rome and to his government. He could also put potential enemies under his own control.

**LITERAL**—What new job did Caesar have when he returned to Rome?

» He became dictator for life.

Have students read the rest of page 40 to themselves. Then guide discussion with the following questions.

**LITERAL**—What did Caesar do as dictator?

» He lowered taxes, appointed new senators, and replaced several greedy governors in the provinces. He gave land to Roman soldiers and food to the poor.

**INFERENTIAL**—Which groups in Rome were most likely to approve of Caesar’s actions?

» The plebeians, the poor, the soldiers, and the farmers who lost their lands.

**LITERAL**—What are three reasons Caesar’s enemies decided to assassinate, or kill, Caesar?

» He ended the republic. He was acting like a king. He might marry Cleopatra and move control of the government from Rome to Alexandria.

## "The Assassination," Page 40

### Scaffold understanding as follows:

**CORE VOCABULARY**—Review the meanings of *assassinate* and *assassination*. Point out that the words come from the same root word: one is a verb, and the other is a noun.

### Read the section aloud. Then ask students the following question:

**LITERAL**—What were Caesar's last words, and what did they mean?

- » After being stabbed, Caesar said, "*Et tu, Brute?*" This means, "You, too, Brutus?" It shows Caesar's surprise and sadness over being betrayed by a friend.

## "Marc Antony and Octavian," Pages 41–42

### Have volunteers read the section "Marc Antony and Octavian" aloud. Scaffold understanding as follows:

**CORE VOCABULARY**—Review the meaning of the term *empire*. Note that this term is used to describe Rome after the end of the republic.

### Then, ask the following questions:

**LITERAL**—Who were the leaders of the group that finally won the civil wars that took place after Caesar died?

- » Marc Antony and Octavian

**LITERAL**—Who was Octavian?

- » He was Caesar's adopted son.

**LITERAL**—What kind of person was Marc Antony?

- » He was ambitious, boastful, courageous, and reckless.

**LITERAL**—Looking at the map on page 41, can you say who ruled in the east and who ruled in the west?

- » According to the map, Marc Antony ruled in the east, and Octavian ruled in the west.

**Marc Antony and Octavian**

After Caesar died, another civil war began. On one side were Brutus and the others who supported the killing of Caesar. On the other side were Caesar's supporters. In 42 BCE Caesar's friends won the war. The leaders of this group were Marc Antony and Octavian.

Marc Antony was a famous general. He wore a thick cape that looked like a lion's skin. He told his soldiers that he was related to the legendary hero Hercules. Hercules had killed a mighty lion and worn its skin as a cape. Antony's soldiers respected his courage in battle, but Antony liked to brag. He could also be careless.

Marc Antony shared control of the government with Caesar's adopted son, Octavian (also known as Octavian). Octavian called himself "the young Caesar." He was eighteen years old when Caesar died. Octavian was the opposite of Antony. He was proper in his dress and manner. He was also careful about his decisions.

**Antony vs. Octavian: The Roman Empire After the Death of Julius Caesar**

The map shows the Roman Empire divided into two regions. The eastern region, labeled 'EAST', is ruled by Marc Antony and includes the Mediterranean Sea, the Black Sea, and the Persian Gulf. The western region, labeled 'WEST', is ruled by Octavian and includes the Atlantic Ocean, the English Channel, and the Bay of Biscay. The map also shows the location of Rome and the Tiber River.

**Page 41** Octavian fought for control of the empire.

Antony and Octavian each took part of the empire to command. Octavian's part was in the west, near Spain. Antony's part was in the east, near Egypt.

**Antony and Cleopatra**

Antony wanted to conquer more lands, but he needed money for his army. He asked Cleopatra to exchange the riches of Egypt for his protection. Cleopatra agreed. She invited Antony to stay with her in Egypt. The two fell in love.

Then Antony's wife died. Though he was free to marry Cleopatra, Antony would not. He knew that many Romans did not trust Cleopatra. She was too clever, too rich, and too powerful. She was also a foreigner.

Antony left Cleopatra, returned to Rome, and married Octavian's sister, Octavia. He knew that important Romans would approve of this marriage. He also believed the marriage would help him keep the peace with Octavian. Still, Antony returned to the east three years later. He went back to his wars of conquest, and he

**Page 42** Antony and Cleopatra fell in love.

The illustration shows a man in a Roman-style tunic and a woman in a purple and gold dress. They are standing in a room with a large window. The woman is holding a small object, possibly a gift or a token of affection. The man is looking at her with a slight smile.

## “Antony and Cleopatra,” Pages 42–43

Things went badly for Antony. He lost half his army and conquered nothing. The army needed food, clothing, and weapons.

Octavia wanted to help her husband. She loaded ships with supplies and sailed to the east. Despite this help, Antony ordered Octavia back to Rome. He made it clear that he preferred Cleopatra to his noble Roman wife.

Octavian was angry. Antony had insulted his sister. Octavian spoke out against Antony and Cleopatra. He said they were planning to take control of the entire Roman world.

Octavian prepared for war. As always, he was careful. He asked Agrippa, Rome's most famous naval commander, to help.

Octavian attacked first. Agrippa trapped Antony and Cleopatra and forced them to fight at sea. They were no match for Agrippa. After their defeat in the Battle of Actium (31 BCE), Antony and Cleopatra escaped to Egypt.

The end came quickly. Antony's army surrendered. Antony killed himself. Cleopatra knew that Octavian would bring her back to Rome in chains. She dressed in her most beautiful costume and held a deadly snake to her skin. When Octavian's guards found her, Cleopatra appeared to be asleep, but she was dead.

**Vocabulary**  
supplies, n. food and other goods that are needed for a certain purpose  
noble, adj. belonging to the highest social class

**Page 43**

Ask student volunteers to read this section aloud, paragraph by paragraph. Scaffold understanding by calling attention to the definitions for each of the following words as they are encountered: *foreigner*, *supplies*, and *noble*.

After volunteers finish reading the section, ask the following question:

**EVALUATIVE**—How did Marc Antony make the same mistake as Julius Caesar?

» He chose Cleopatra over Rome.

## Timeline

- Show students the Chapter 7 Timeline Image Cards. Read and discuss the captions, making particular note of any dates.
- Review and discuss the Big Question, “What were the reasons behind the actions taken against Julius Caesar and Marc Antony?”
- Post the image cards as the sixth and seventh images on the Timeline, under the date referencing 100 BCE–99 CE; refer to the illustration in the Unit 2 Introduction for further guidance on the placement of each image card to the Timeline.



### CHECK FOR UNDERSTANDING 5 MIN

Ask students to do one of the following:

- **Turn and Talk**—Ask a partner the answer to the Big Question, “What were the reasons behind the actions taken against Julius Caesar and Marc Antony?”
  - » Key points that students may list are: Caesar became a dictator for life, and he placed a statue of Cleopatra in a temple in Rome. Marc Antony fell in love with Cleopatra and lost battles and half his army. He also mistreated his wife—Octavian’s sister—so he could be with Cleopatra.
- Choose one of the Core Vocabulary words (*assassinate*, *toga*, *empire*, *foreigner*, *supplies*, or *noble*), and say a sentence aloud using the word.

To wrap up the lesson, ask several students to share their responses.

## Additional Activities

### Antony and Octavian

30 MIN

Activity Page



AP 7.1

**Materials Needed:** Sufficient copies of Antony and Octavian (AP 7.1), found in the Teacher Resources section (page 150).

Distribute the Antony and Octavian activity page. Have students work in pairs to compare and contrast the two men by completing the Venn diagram. Help students by prompting them to think about what career and background the two men shared. Ask also how they differed in how they made decisions and in their manners.

When students have completed their diagrams, briefly review as a class the similarities and differences between Antony and Octavian.

### Domain Vocabulary: Chapters 5–7 (L.3.6)

30 MIN

Activity Page



AP 7.2

**Materials Needed:** (1) Colored pencils or markers, (2) sufficient copies of Domain Vocabulary: Chapters 5–7 (AP 7.2), found in the Teacher Resources section (pages 151–152).

Distribute Domain Vocabulary: Chapters 5–7 (AP 7.2). Students should complete the activity by using the clues to identify the correct Core Vocabulary words, write the words in the spaces provided, and then find and circle the words in the puzzle. The puzzle uses vocabulary from Chapters 5–7 with some review words from Chapters 1–4. Direct students to use a colored pencil or marker of the same color to circle the definition and the word in the puzzle itself.



# Caesar Augustus

**The Big Question:** What were some of Caesar Augustus’s many accomplishments?

## Primary Focus Objectives

---

- ✓ Identify Octavian and Caesar Augustus as the same person, known by two different names. **(RI.3.2)**
- ✓ Identify the accomplishments of Caesar Augustus. **(RI.3.2)**
- ✓ Describe Caesar Augustus’s behavior toward the Senate. **(RI.3.2)**
- ✓ Understand the meaning of the following domain-specific vocabulary: *aqueduct*, *patron*, and *emperor*; and of the phrase “religious ceremony.” **(RI.3.4)**

## What Teachers Need to Know

---

To learn more about specific topics in the unit, download the CKHG Online Resource “About Caesar Augustus”:

[www.coreknowledge.org/ckhg-online-resources](http://www.coreknowledge.org/ckhg-online-resources)

## Core Vocabulary **(Student Reader page numbers listed below)**

---

**aqueduct, n.** a structure for carrying water across long distances **(47)**

*Example:* The Romans built an aqueduct to bring water into the city.

*Variation(s):* aqueducts

**“religious ceremony,” (phrase),** a formal event to honor a god or goddess **(48)**

*Example:* The old religious ceremony had great meaning for many Romans.

*Variation(s):* religious ceremonies

**patron, n.** a person who gives money or other support to someone, such as an artist **(49)**

*Example:* The wealthy Roman became a patron to the author by giving him money so that he could keep writing books.

*Variation(s):* patrons

**emperor, n.** the ruler of an empire **(49)**

*Example:* Caesar Augustus was the first emperor of Rome, even though he never used the title.

*Variation(s):* emperors

## Introduce “Caesar Augustus”

5 MIN

Remind students that Octavian emerged the victor of all the conflicts that followed Caesar’s death. These conflicts followed the assassination of Julius Caesar, who was killed because, in the view of some Romans, he had grown too powerful.

Introduce the Big Question. Tell students that in this chapter they will learn more about Octavian and his accomplishments.

## Guided Reading Supports for “Caesar Augustus”

20 MIN

When you or a student reads aloud, **always** prompt students to follow along. By following along, students may acquire a greater understanding of the content. Remember to provide discussion opportunities.

### “Octavian’s Return” and “Closing the Doors of War,” Pages 44–46

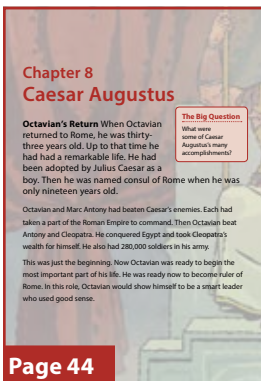

Invite a volunteer to read each section. After finishing “Closing the Doors of War,” ask the following questions:

**LITERAL**—How did Octavian become the ruler of Rome?

- » He defeated Antony and Cleopatra.

**LITERAL**—What did Octavian do during his victory celebration? Why was that important?

- » He closed the gates of the Temple of Janus. It signaled that he would rule in peace.

**LITERAL**—How did Octavian fulfill his promise?

- » He disbanded the army and gave land to his soldiers. He returned to his job as consul.



## “Octavian Becomes Augustus,” Pages 46–47

### Closing the Doors of War

Octavian showed his smart leadership shortly after he returned from Egypt. At that time, the Roman people were celebrating Octavian's victory, which ended the civil war and saved Rome. Octavian led a crowd to the temple of Janus. The temple's gates were left open during times of war. They were closed during peacetime. Rome had almost always been at war, so the gates had rarely been closed.

Octavian closed the gates. This act showed the Roman people they would now live in peace. Octavian then set out to fulfill this promise.

Soon afterward, Octavian bought land for his soldiers. He told them it was time to leave the army and go back to being farmers.

Octavian himself went back to his job as consul. He was reelected three years in a row. Then he told the Senate he wanted to give back all his power. He would serve Rome in any way the Senate decided.

### Octavian Becomes Augustus

The Senate decided that Octavian should command the armies in all the large provinces. They also decided that Octavian should have a new name. He was to be called *Caesar Augustus* (*aw-gus-tus*). *Augustus* is a Latin word that means revered one. To be revered is to be the most admired and respected.

Augustus was named the First Citizen of Rome, and the month of his birth was renamed for him. Today, we call that month August, in honor of Julius Caesar.

Page 46

Have students read the section to themselves. When students have finished, ask the following questions:

**LITERAL**—What titles were given to Octavian?

- » Caesar (Augustus) and First Citizen of Rome.

**EVALUATIVE**—Why was it important that these titles came from the Senate and not from Augustus himself?

- » It showed how much he meant to the people of Rome and also that he planned to work with the Senate and not against it.

**EVALUATIVE**—How was Augustus's relationship with the Senate different from Julius Caesar's relationship with the Senate?

- » Augustus showed respect for the Senate, and he tried to cooperate with the senators. Julius Caesar did not work well or have a good relationship with the Senate.

## “Augustus Rebuilds Rome” and “Rome's First Emperor,” Pages 47–49

Invite student volunteers to read the two remaining sections, paragraph by paragraph, and scaffold understanding of each vocabulary word below as it is encountered in a given paragraph.

**CORE VOCABULARY**—Review the term *aqueducts* that appears in the first paragraph under “Augustus Rebuilds Rome.” Point out that this term has two parts: *aque*, which means water, and *duct*, which is a tube or passageway through which something passes.

**CORE VOCABULARY**—After a volunteer reads the last full paragraph on page 48, invite students to identify and define the two words that make up the phrase “religious ceremony.”

**CORE VOCABULARY**—After a student reads the last paragraph of the section “Augustus Rebuilds Rome,” reread the sentence, “He asked wealthy Romans to be patrons to writers.” Ask students to explain in their own words what this means.

**CORE VOCABULARY**—After a volunteer reads the first paragraph under the heading “Rome's First Emperor,” ask students to share other vocabulary words from the unit that have a meaning similar to *emperor* (*king, dictator*).

Augustus was not a king or a dictator. All his power came from the Senate. He was always respectful of the senators and the assemblies. The senators trusted Augustus because he used his power wisely.

Augustus used his power to name new governors for the provinces and new senators. He also made changes in the Roman army. He paid soldiers more money. This helped make the army a good place for poor men to earn a living.

Augustus built good roads throughout the Roman Empire. These roads connected Rome and the provinces. Augustus often visited the provinces to check if the governors were doing a good job.

### Augustus Rebuilds Rome

At the end of the civil war, Rome was a dirty, overcrowded city. Most of the streets and buildings needed repair. The aqueducts, which carried water to the city, were also crumbling.

Many people who had lost their land during the civil war now lived in Rome. They were poor and hungry. They lived in old buildings that often caught fire.



Augustus had Rome to new heights of glory.

**Vocabulary**  
*aqueduct*, a structure for carrying water across long distances.

Page 47

Augustus bought food for the poor. He rebuilt many old buildings. He made laws to require that all buildings meet safety standards. He started Rome's first fire and police departments. He put Agrippa, his naval commander, in charge of the city's water supply. Agrippa and his forces rebuilt the old aqueducts.

Augustus wanted everyone to know about the citizens who had helped to make Rome great. He built a beautiful new Forum in Rome. Around this new Forum, he placed statues of Roman heroes.

Augustus filled the city with beautiful new buildings. He built theaters, meeting places, and a grand new Senate building. He changed Rome from a dirty, ugly place to one of the most beautiful cities in the world.

Augustus also helped make Roman religion stronger. He repaired Rome's old temples and built new ones. He brought back many old religious ceremonies and festivals.

Augustus loved books and ideas. He often visited with writers and poets to



The beautiful Parthenon was used to worship all of the Olympian gods. The original Parthenon was built by Agrippa during the rule of Augustus.

Page 48

work aloud. He asked wealthy Romans to be patrons to writers. These patrons gave money to writers so they could keep writing. During the time of Augustus, talented writers wrote many great works. People today still read some of these great works.

**Rome's First Emperor**

Rome honored Augustus for rebuilding the city and making life better for the people. They named him "Father of His Country." Later, he was called Rome's first emperor.

Augustus was the most powerful man in the world, yet he lived simply. His house was small. His meals were plain. He was loyal to his wife and family and the Roman people.

Augustus ruled as emperor from 27 BCE until 14 CE. The letters "CE" stand for the phrase Common Era. The Common Era began with the birth of Jesus. So, Augustus ruled until fourteen years after the birth of Jesus.

**Vocabulary**  
patron, n. a person who gives money or other support to someone, such as an artist.  
emperor, n. the ruler of an empire.



Caesar Augustus had a long and successful rule.

**Page 49**

## When students have finished reading, ask the following questions:

### LITERAL—What are three things Augustus did to improve life in Rome?

- » Possible answers: He built good roads throughout the Roman world, bought food for the poor, rebuilt crumbling buildings, made safe building laws, started fire and police departments, and improved the water supply. He also put up statues of Roman heroes to help increase people's pride in their culture. He beautified the Forum, built beautiful theaters and public buildings, revived temples and religious rituals, and encouraged support for writers and poets.

### EVALUATIVE—How might Augustus's simple lifestyle have affected other people's opinion of him?

- » He didn't show off or make it seem that he thought he was better than everyone else. This would make people like him and want to follow his lead.

### CHALLENGE—How were Augustus and Julius Caesar alike? How were they different?

- » They both tried to help the poor; they both made changes in government; they were both powerful. Augustus was able to get leading Romans as well as ordinary people on his side, whereas Julius Caesar worried and frightened the wealthy people of Rome.

### CHALLENGE—Knowing that Augustus rejected the title emperor but accepted the title First Citizen of Rome, can you explain the difference between being an emperor and a First Citizen?

- » *Emperor* sounds as if the person is above everyone else, but First Citizen sounds as if that person is one of the people.

## Timeline

- Show students the Chapter 8 Timeline Image Card. Read and discuss the captions, making particular note of any dates.
- Review and discuss the Big Question, "What were some of Caesar Augustus's many accomplishments?"
- Post the image card as the eighth image on the Timeline, under the date referencing 100 BCE–99 CE; refer to the illustration in the Unit 2 Introduction for further guidance on the placement of each image card to the Timeline.



## CHECK FOR UNDERSTANDING 5 MIN

### Ask students to do one of the following:

- **Turn and Talk**—Ask a partner to answer the Big Question, “What were some of Caesar Augustus’s many accomplishments?”
  - » Key points students should cite include: Augustus pledging peace by closing the gates of the Temple of Janus; building roads; providing food and land; rebuilding old buildings and aqueducts; and reviving the Roman religion.
- Choose one of the Core Vocabulary words or phrases (*aqueduct*, “religious ceremony,” *patron*, or *emperor*), and say a sentence aloud using the word.

To wrap up the lesson, ask several students to share their responses.

## Additional Activities



### Comparing Sources About Augustus (RI.3.9)

30 MIN

#### Activity Page



AP 8.1

**Materials Needed:** (1) Sufficient copies of Comparing Sources About Augustus (AP 8.1), found in the Teacher Resources section (page 153), (2) Internet access or printed copies of the BBC’s “World History: Head of Emperor Augustus.”

Use this link to download the CKHG Online Resources for this unit, where the specific link to “Head of Emperor Augustus” may be found.

**[www.coreknowledge.org/ckhg-online-resources](http://www.coreknowledge.org/ckhg-online-resources)**

Distribute Comparing Sources About Augustus (AP 8.1). Explain that the chart works like a Venn diagram. Students will fill in the left column with details found only in Source 1, Student Reader Chapters 7 and 8; and the right column with details found only in Source 2, the BBC’s “World History: Head of Emperor Augustus.” Details that are found in both sources will be listed in the middle column.

Have students read both sources and then work in pairs to complete the activity.

As an alternative, the activity might also be completed with any print children’s encyclopedia or other appropriate reference source that includes a biography of Augustus.

# Roman Lands

**The Big Question:** How did the Mediterranean Sea and Roman roads help the Romans manage their empire?

## Primary Focus Objectives

- ✓ Locate the Roman Empire on a world map. **(RI.3.7)**
- ✓ Identify the countries that occupy that area today. **(RI.3.7)**
- ✓ Identify the dominant natural features of the Roman Empire. **(RI.3.7)**
- ✓ Understand the meaning of the following domain-specific vocabulary: *continent*, *mountain range*, *strait*, and *kingdom*. **(RI.3.4)**

## Materials Needed

Activity Page



AP 1.3  
AP 9.1

Display copy of Map of the Mediterranean Region (AP 1.3), found in the Teacher Resources section (page 139); display copy of Geography of the Roman Empire (AP 9.1), found in the Teacher Resources section, page 154, or sufficient copies for students.

## Core Vocabulary (Student Reader page numbers listed below)

**continent, n.** one of the seven large land areas on Earth **(50)**

*Example:* Rome is located on the Italian peninsula, which is part of the continent of Europe.

*Variation(s):* continents

**mountain range, n.** a line of mountains **(52)**

*Example:* The Alps are the mountain range that Hannibal crossed to reach Italy from Spain.

*Variation(s):* mountain ranges

**strait, n.** a narrow body of water that connects two large bodies of water **(53)**

*Example:* The Strait of Gibraltar connects the Atlantic Ocean and the Mediterranean Sea.

*Variation(s):* straits

**kingdom, n.** a country ruled by a king or queen **(54)**

*Example:* Rome began as a kingdom.

*Variation(s):* kingdoms

## Introduce “Roman Lands”

5 MIN

 **Note:** This chapter provides a good review of the geography of the Roman Empire.

Display the Map of the Mediterranean Region (AP 1.3). Review with students the geographic areas that have been mentioned so far in the unit: Rome, Greece, Spain, Carthage, Gaul, and Egypt. Note that while these places are not on the same continent, they have the Mediterranean Sea in common.

Introduce the Big Question. Explain that although the Romans eventually built roads throughout their empire, few roads existed in the western provinces before the Roman conquest. (The eastern provinces were better supplied with roads.) Therefore, it was easier to travel by sea than to travel over land.

## Guided Reading Supports for “Roman Lands”

20 MIN

When you or a student reads aloud, **always** prompt students to follow along. By following along, students may acquire a greater understanding of the content. Remember to provide discussion opportunities.

### “The Roman World,” Pages 50–52

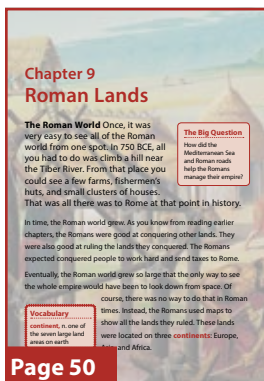

Invite a volunteer to read the section aloud. Scaffold understanding as follows:

**CORE VOCABULARY**—After the entire section is read aloud, review the vocabulary word *continent*. Challenge students to recall the names of all seven continents.

Then, ask the following questions:

**LITERAL**—Thinking about what you read back in Chapter 1, why do you think Rome was founded on a hill near the Tiber river?

- » According to legend, it was where Romulus and Remus were found and saved by a mother wolf. In reality, the soil was good for farming, the river made travel easy, and the hill provided protection.

**LITERAL**—Looking at your map on page 52, on what three continents did Romans conquer lands?

- » Europe, Asia, and Africa.

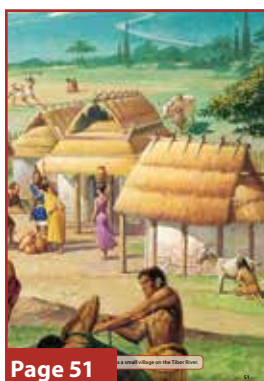

**The Roman Empire, 117 CE**

Areas controlled by the Roman Empire, 117 CE

Rome's empire spread from the Italian peninsula through most of Europe and parts of Asia and Africa.

The map shows the Roman Empire when it was very large. Let's take a tour.

**Italy and the Mediterranean**

The city of Rome is located on the Italian peninsula. Do you see it? If you can't find the Italian peninsula, look for the piece of land that looks like a boot. Do you see the toe and the high heel?

The Italian peninsula is part of the continent of Europe. Between the Italian peninsula and the rest of Europe are the Alps. The Alps are a high, snow-covered mountain range. Hannibal and his elephants crossed the Alps.

**Vocabulary**  
mountain range, n.  
a line of mountains

**Page 52**

**CHALLENGE:** On which continent did the Romans make their first conquests? How do you know?

- » The Romans' first conquest was on the continent of Europe. Rome is in Europe, and the first people that the Romans conquered were their neighbors on the Italian peninsula.

**“Italy and the Mediterranean,” “Greece and the Balkans,” “Asia and Africa,” and “Back to Europe,” Pages 52–55**

**Read all of the sections describing the geography of the Roman Empire aloud. Scaffold understanding as follows:**

**SUPPORT**—Instead of having students follow along in the text, you may wish to have them focus on the map of the Roman Empire on page 52 of the Student Reader and trace the route as you read. As an alternative, you can also display or distribute Geography of the Roman Empire (AP 9.1) for students to follow along.

**CORE VOCABULARY**—Direct students' attention to the last paragraph on page 52. Note the Core Vocabulary term *mountain range*, and review the definition. Ask students to name other mountain ranges they are familiar with.

**CORE VOCABULARY**—Direct attention to the second paragraph in the section “Greece and the Balkans.” Identify the Core Vocabulary term *strait*. Read the definition, and invite volunteers to locate the narrow waterway on the map on page 52.

**CORE VOCABULARY**—In the first paragraph on page 54, point out the term *kingdom*. Have a volunteer read the definition provided on the Student Reader page.

**After reading the sections, ask the following questions:**

**LITERAL**—Why did the Romans call the Mediterranean “our sea”?

- » The Romans referred to the Mediterranean Sea as “our sea” because they controlled all of the land around the Mediterranean.

The Italian peninsula sticks into the Mediterranean Sea. Once the Romans controlled the Italian peninsula, they conquered islands and coastal areas around the Mediterranean. After a while, the Romans controlled the whole Mediterranean region. They called the Mediterranean “our sea.”

**Greece and the Balkans**

The Adriatic Sea is northeast of the Italian peninsula. Across the Adriatic Sea is Greece. As you know, ancient Greece was very important to the Romans. The Romans liked Greek ideas about education, art, building, and government. They used these ideas in Rome. They also brought these ideas to their provinces.

East of Greece is the Aegean Sea. The Aegean is connected to another large body of water: the Black Sea. These two seas are connected by a narrow waterway, or strait. This strait is called the Bosphorus. It separates Europe from Asia Minor.

The Bosphorus passes through a city that was once called Constantinople. Today its name is Istanbul. This city was important to the Roman Empire. You will learn more about it later.

**Asia and Africa**

Constantinople is on the tip of the peninsula called Asia Minor. Today the peninsula is home to the nation of Turkey. Two thousand years ago, it was part of the Roman Empire. It is from this part of the Roman Empire that the famous “Noi, vici, vis” message came.

**Vocabulary**  
strait, n.  
a narrow body of water that connects two larger bodies of water

**Page 53**

The Romans also controlled Mesopotamia and the Kingdom of Egypt. Egypt was the home of Cleopatra. It was also one of the richest of Rome's provinces. It had ports on the Mediterranean Sea and the Red Sea. It also had rich lands along the Nile River.

The ruins of the Library of Celsus in Ephesus, Turkey, an ancient Roman building.

The Romans had provinces along the North African coast too. Carthage controlled some of that coastline until the end of the Third Punic War. Then Rome gained control of the land.

**Back to Europe**

At the western end of the North African coastline is the Strait of Gibraltar. This strait connects the Mediterranean Sea and the Atlantic Ocean. Spain is north of Gibraltar, on the continent of Europe. The Romans conquered Spain. Then, Julius Caesar conquered the large area to the north. The Romans called this area Gaul. Today, we call this area France.

**Vocabulary**  
kingdom, n.  
a country ruled by a king or queen

**Page 54**

The Romans also had an island province north of Europe. They called this province Britannia. Today this land is part of Great Britain.

**All Roads Lead to Rome**

To control such a large empire, Roman officials needed a way to travel easily. To do this, they built roads. These roads were paved with smooth slabs of stone. The Roman army could travel quickly over the paving stones to get where it was needed.

The Appian Way, the most famous road of ancient Rome, was built in 312 BCE. Part of the road is still in use.

The Roman Empire had more than fifty thousand miles of roads. These roads connected every province of the empire to Rome itself. That is why the Romans said, “All roads lead to Rome.” Today, in areas of Asia, Africa, and Europe, some highways and railroad lines still follow the routes of the ancient Roman roads.

**Page 55**



**EVALUATIVE**—What geographic barriers, land or water, did the Romans encounter as they expanded their empire?

- » The Romans overcame the barriers of the Mediterranean Sea, the Alps, the Aegean Sea, and the Red Sea.

### “All Roads Lead to Rome,” Page 55

**Invite a volunteer to read the section aloud. After reading the section, ask the following questions:**

**LITERAL**—Where did the saying “All roads lead to Rome” come from?

- » The Roman Empire had a network of more than fifty thousand miles of roads that connected every province to the city of Rome.

**INFERENTIAL**—Knowing that parts of some Roman roads, such as the Appian Way, survive today, more than two thousand years after they were built, what can we say about the Romans?

- » They were good builders. They knew how to make strong roads. Their roads have remained useful throughout history.



### CHECK FOR UNDERSTANDING 5 MIN

**Ask students to do one of the following:**

- **Turn and Talk**—Ask a partner to answer the Big Question, “How did the Mediterranean Sea and Roman roads help the Romans manage their empire?”
  - » Key points students should cite include: they allowed governors and soldiers to travel relatively easily and quickly from Rome to the many provinces of the empire.
- Choose one of the Core Vocabulary words (*continent*, *mountain range*, *strait*, or *kingdom*), and say a sentence aloud using the word.

To wrap up the lesson, ask several students to share their responses.

## Additional Activities



### Geography of the Roman Empire

30 MIN

Activity Pages



AP 9.1

**Materials Needed:** Sufficient copies of Geography of the Roman Empire (AP 9.1), found in the Teacher Resources section (pages 154–155).

Distribute copies of Geography of the Roman Empire (AP 9.1). Have students use the map to answer the questions. This activity page may also be assigned for homework.



### Then and Now

30 MIN

Activity Pages



AP 9.1

AP 9.2

**Materials Needed:** (1) Sufficient copies of Then and Now (AP 9.2) from Teacher Resources (page 156); (2) access to a print or online map of the modern Mediterranean region to display or provide copies for students; (3) map of the Roman Empire from Student Reader, page 52, or from Teacher Resources (AP 9.1), page 154.

Tell students that the names of some parts of the Roman Empire have changed over time, while others have stayed the same. In this activity, students will compare the map of the Roman Empire in this unit (either on Student Reader page 52 or in AP 9.1) with a modern map to determine the current names of locations formerly within the empire.

Distribute Then and Now (AP 9.2), and have students work with a partner to identify the modern names of the locations listed in the activity. Review responses with the entire class.



### Roman Roads

15 MIN

Use the link to download the CKHG Online Resources for this unit, where links to a video about Roman roads may be found:

**[www.coreknowledge.org/ckhg-online-resources](http://www.coreknowledge.org/ckhg-online-resources)**

Show the video about the Roman road system, “Rome’s Ancient Highways.”

Use the video to launch a discussion comparing Roman roads with modern transportation networks.

# Roads, Bridges, and Aqueducts

**The Big Question:** How did Roman engineering skills help the Roman Empire become so successful?

## Primary Focus Objectives

---

- ✓ Recognize the network of roads, bridges, and aqueducts as an important strength of the Roman Empire. **(RI.3.2)**
- ✓ Understand the technology used to build these structures. **(RI.3.2)**
- ✓ Explain how aqueducts were used. **(RI.3.2)**
- ✓ Understand the meaning of the following domain-specific vocabulary: *scroll, gravel, surface, valley, pillar, stake, and arch*. **(RI.3.4)**

## What Teachers Need to Know

---

For background information, download the CKHG Online Resource “About Life in the Roman Empire”:

[www.coreknowledge.org/ckhg-online-resources](http://www.coreknowledge.org/ckhg-online-resources)

## Core Vocabulary (Student Reader page numbers listed below)

---

**scroll, n.** a roll of paper or other material with written information **(56)**

*Example:* The student unrolled the scroll that contained the ancient writing.

*Variation(s):* scrolls

**gravel, n.** tiny stones used to make paths or to make concrete **(59)**

*Example:* The Romans used gravel to help make their roads strong.

**surface, n.** the top layer **(59)**

*Example:* The surface of a Roman road was usually made with flat rocks.

**valley, n.** a low area of land surrounded by higher ground, such as hills or mountains (60)

*Example:* From its position on a hill near the Tiber River, Rome looked down over a valley.

*Variation(s):* valleys

**pillar, n.** a tall, solid support post (60)

*Example:* The workers built a pillar to help hold up the bridge.

*Variation(s):* pillars

**stake, n.** a thin, pointed post (60)

*Example:* The worker pounded a wooden stake into the bottom of the river.

*Variation(s):* stakes

**arch, n.** a curved structure that has an opening below and that supports something above (60)

*Example:* The bricks formed an arch, which helped support the aqueduct.

*Variation(s):* arches

## THE CORE LESSON 25 MIN

### Introduce “Roads, Bridges, and Aqueducts”

5 MIN

Remind students that in the last chapter they learned that Augustus built roads, bridges, and aqueducts throughout the Roman Empire. Ask students if they’ve ever seen roads, bridges, or water mains under construction. What kinds of equipment were being used? What kinds of materials?

Draw students’ attention to the Big Question. Explain that the ancient Romans did not have such heavy equipment or modern materials. They had to rely on human and animal muscle power to build with rock, timber, and concrete. Yet they were able to construct good roads and bridges. Some of them are still around—two thousand years later! Tell students that in this chapter they will read about how the Romans built a network of roads, bridges, and aqueducts. The chapter uses historical fiction and the make-believe characters of Linus and Lucia as a way to introduce historical information about Rome’s roads, bridges, and aqueducts.

When you or a student reads aloud, **always** prompt students to follow along. By following along, students may acquire a greater understanding of the content. Remember to provide discussion opportunities.

## “Grandfather’s Traveling School,” Pages 56–59

Read this section aloud to students. Scaffold understanding as follows:

**CORE VOCABULARY**—Read the second paragraph under “Grandfather’s Traveling School” with students. Note the definition of the word *scroll* on the page. Direct students’ attention to the illustration on page 57, which shows an example of a scroll.

When you have finished reading, ask the following questions:

**LITERAL**—Why is Grandfather upset?

- » Linus and Lucia have woken him up. He realizes his grandchildren do not know much about Rome.

**LITERAL**—What is Grandfather going to do?

- » He is going to take Linus and Lucia to Rome.

**INFERENTIAL**—Is Linus’s family patrician or plebeian? How do you know?

- » They are patricians. Grandfather is a senator, and they live in a villa in the countryside.

**Chapter 10**  
**Roads, Bridges, and Aqueducts**

**Grandfather’s Traveling School**  
One morning in 100 C.E., a Roman patrician named Marcus heard the slap of small sandals on the stone floor of his villa. Marcus wondered which of his children was up so early.

**The Big Question**  
How did Roman engineering skills help the Roman Empire become so successful?

**Vocabulary**  
**scroll**, n. a roll of paper or other material with written information.  
The slapping sound grew louder. Then Marcus saw Linus, his seven-year-old son, carrying a great armload of scrolls. At that moment, the footsteps were interrupted by an awful crash. Then came the sound of heavy scrolls bouncing and rolling on the smooth stone floor.  
Marcus hurried into the hall. Linus was trying to gather up the scrolls. Lucia, Linus’s eleven-year-old sister, was shaking her head and scolding her brother.

**Page 56**



*Gaudeamus igitur,  
iuvenes dum  
sumus.*

Real information—such as this saying, which means “we’re young!”

**Page 57**

“Now you have woken Father. Why can’t you be careful! Next you will wake Grandfather!”

She was right. Grandfather was awake. And he had a message for his grandson.

“You won’t find answers in those scrolls, boy. You and your sister have a lot to learn. You won’t learn it crawling around my villa in the dark. Tell Nikos, your teacher, that we are going to Rome. But first, I’ll have a word with your father!”

Marcus smiled at his father as the older man led them outside.

“Marcus, my grandchildren have been in the countryside too long. I asked them some questions yesterday. They know almost nothing about Rome. They have never even seen an aqueduct! It



**Page 58**

## “Road Building,” Pages 59–60

Invite a volunteer to read the entire section aloud. Scaffold understanding as follows:

**CORE VOCABULARY**—Read the third paragraph in this section. Review the definitions of *gravel* and *surface*. Explain that these are two distinct parts of a road. Ask students to define each term. Then have them identify where they might find gravel today and identify which part of their desk or table is the surface.

After reading, ask the following questions:

**LITERAL**—What are the three steps to making a Roman road?

- » Step 1 in building a road is to dig a trench. Step 2: fill the trench with stones and gravel. Step 3: lay down smooth stones to form the road’s surface.

**INFERENCE**—Why does Grandfather say the roads are Rome’s “most valuable treasure”?

- » Roads helped the Romans to rule their vast provinces once they conquered them. Rome’s smooth stone roads allowed officials, governors, tax collectors, messengers, and merchants to travel over land much more easily than they could on dirt or gravel roads. Paved roads also allowed soldiers to travel over land to defend the far-flung Roman Empire. And although travel by river and sea was cheaper and easier than land travel, the roads formed an important network.

It is time they learned. As head of the family, I’m going to see to it. They will be in my traveling school beginning today.”

Marcus was grateful to his father, who was a Roman senator. Linus and Lucia were getting a wonderful gift.

Linus and Lucia climbed aboard a large wagon. Nikos, the teacher, was next. They were followed by two servants, who would cook meals and care for the horses.

The senator wore a purple-trimmed toga and rode a beautiful black horse. He waved good-bye to Marcus and rode away, followed by his guards and the heavy wagon.

**Road Building**

“Linus and Lucia, you are going to learn how to build a road,” said Grandfather. “Climb down. We’ll walk from here.”

The group walked toward a cloud of dust in the distance. As they neared the dust cloud, they saw hundreds of men digging and carrying stones.

Their grandfather explained: “First these men dig a trench, which is a big hole in the ground. They fill the trench with large stones and gravel. Then they lay down smooth slabs of stone to make the road’s surface. They also make the road a little higher in the middle. That way, the rain will flow off it.”

“Nikos will show you a map of the Roman roads, which connect these fine roads are one of our most”

**Vocabulary**

**gravel**, *n.* tiny stones used to make paths or to make concrete

**surface**, *n.* the top layer

**Page 59**

“Next,” Grandfather continued, “we’re going to see where this road is going. We will have a good view from that hilltop.”

**Bridge Building**

The view was very good indeed. The road was headed across a broad valley toward a wide river. Hundreds of men were building a bridge across the river.

Again, the senator explained how it was done. “First, they tie two boats up side by side. Then they build a wooden platform across them. They add more boats and make the platform longer until it stretches all the way across the river.”

“When the long platform is finished, they build underwater pillars. These support the bridge.”

“How do they build the pillars?” the children asked.

“They pound a wooden stake into the bottom of the river,” the older man explained. “Then they put another stake next to it, and another, until they make a circle of stakes. They pull chains around the stakes to make the circle very tight. That way, no water can leak in between the stakes.”

“When the chains are tight, they empty out the water inside the circle. Then they build a stone pillar inside the circle of stakes. They build all the pillars the same height. Then they connect them with”

**Vocabulary**

**valley**, *n.* a low area of land surrounded by higher ground, such as hills or mountains

**pillar**, *n.* a tall, solid support post

**stake**, *n.* a thin, pointed post

**arch**, *n.* a curved structure that has an opening below and that supports something above

**Page 60**

## “Bridge Building,” Pages 60–61

Invite a volunteer to read the entire section aloud. Scaffold understanding of each vocabulary word as it is encountered during the read-aloud as follows:

**CORE VOCABULARY**—When you come to the term *valley* in the first paragraph, provide the definition from the Student Reader.

**CORE VOCABULARY**—In the third paragraph, note the Core Vocabulary term *pillars*. Make sure students recognize that a pillar is a vertical part of a bridge.

**CORE VOCABULARY**—In the fifth paragraph, note the term *stake*. Explain that the process described in the text of making a pillar involves the use of many individual stakes.

**CORE VOCABULARY**—Ask a volunteer to read the final paragraph on page 60. When you come to the Core Vocabulary term *arches*, provide the definition. Point to the illustration on page 61, and have students identify the arches in that image.

“Next they build another platform over the arches. Then they replace the wooden arches and the wooden platform with stone to finish the bridge. The stone bridge will be strong enough to hold a Roman army legion.”

**Aqueducts**

“What is that?” Lucia asked. “It looks like a bridge, but it is so much larger and so high in the air. What is it, Grandfather?”

“It is an aqueduct. It carries water from the mountain lakes to the city of Rome. The aqueduct is a great pipe that carries water high over valleys and hillsides,” Grandfather replied.

“Aqueducts are built like bridges. Arches of stone connect stone support pillars. The great pipe lies on top of the arches the way the road lies on the arches of the bridge,” he continued.

The two children stared in wonder.



**Page 61**

**After the student finishes reading, ask the following questions:**

**LITERAL**—What important shape gave the Roman bridges their strength?

- » the arch

**INFERENTIAL**—Why did the Romans need math to help them build a bridge?

- » They had to measure the depth of the river to know how tall a stake to use. They had to be able to count stakes so all the pillars would be the same size around. They had to measure the height of the pillars to make sure they were all the same height. They had to measure the distance between pillars to make the arches.

**INFERENTIAL**—Why were bridges important?

- » You can't walk around a river. And although there may be places where a river is shallow enough for people or horses to walk across, crossing a river is uncomfortable at best and can be very dangerous. It's also hard to carry goods across a river.

**"Aqueducts," Page 61**

**Read the section aloud. Then ask the following questions:**

**LITERAL**—What were aqueducts, and what were they used for?

- » They were arched supports for pipes that carried water from the mountain lakes down into the city of Rome and other cities of the Roman Empire.

**CHALLENGE**—(Remind students that the word *aqueduct* comes from the Latin word for "water" plus the word for "to lead" or "to bring." An aqueduct is literally a structure that brings water from one place to another.) What are some other "aque" or "aqua" words that have to do with water?

- » aquarium, aquanaut, and aquatic

**EVALUATIVE**—How were aqueducts similar to bridges? How were they different?

- » They are built in a similar way, with pillars and arches. They are different in size and purpose. Aqueducts carry water over land; bridges carry people and animals over water. Aqueducts can be much longer than bridges, if they have to carry water a long distance.



## CHECK FOR UNDERSTANDING 5 MIN

### Ask students to do one of the following:

- **Turn and Talk**—Ask a partner to answer the Big Question, “How did Roman engineering skills help the Roman Empire become so successful?”
  - » Key points students should cite include: Roads helped people and supplies travel from one part of the empire to another. Bridges made it possible for people and supplies to cross rivers. Aqueducts carried water into Rome and other cities of the Roman Empire.
- Choose one of the Core Vocabulary words (*scroll, gravel, surface, valley, pillar, stake, or arch*), and say a sentence aloud using the word.

To wrap up the lesson, ask several students to share their responses.

## Additional Activities

### Roads and Bridges (L.3.6)

20 MIN

Activity Page



AP 10.1

**Materials Needed:** Sufficient copies of Roads and Bridges (AP 10.1), found in the Teacher Resources section (pages 157–158).

Distribute Roads and Bridges (AP 10.1). Have students label each diagram by referring to the descriptions in Chapter 10 of the *Ancient Rome Student Reader*.



### How-To Brochures (W.3.2)

30 MIN

**Materials Needed:** 1) Legal-size copy paper, (2) markers, crayons, or colored pencils.

Organize students into small groups. Have each group use the information in Chapter 10 of the *Ancient Rome Student Reader* to create a how-to brochure that explains how to build a Roman road, how to build a Roman bridge, or how to build a Roman aqueduct.

You may assign a topic to each group or allow each group to choose its own topic.

The brochures should be made using tri-folded legal-size copy paper and contain both images and text.





**Materials Needed:** Access to the Internet images of the Pont du Gard; use this link to download the CKHG Online Resources for this unit, where specific links for this activity may be found:

[www.coreknowledge.org/ckhg-online-resources](http://www.coreknowledge.org/ckhg-online-resources)

**Alternate Art Activity for the Pont du Gard: If you do not have classroom access to the Internet, you can purchase the Core Knowledge Curriculum Series™ Art Resource packet for Grade 3, available at:**

[www.coreknowledge.org/store](http://www.coreknowledge.org/store)

**Use this art resource to guide students through the following activity.**

Take this opportunity to reinforce the domain-specific vocabulary words *valley*, *aqueduct*, *pillar*, and *arch* by introducing students to one of the most stunning examples of a Roman aqueduct, the Pont du Gard in France.

 **Background for Teachers:** Prior to discussing Pont du Gard with students, use this link to download the CKHG Online Resources where the specific links to the following images may be found:

[www.coreknowledge.org/ckhg-online-resources](http://www.coreknowledge.org/ckhg-online-resources)

Before conducting the Virtual Field Trip, you may wish to preview and curate specific images from the slide show “UNESCO Pont du Gard Gallery”, as well as the images “An Ancient Work of Art” and “The Pont du Gard: 2000 Years of History.”

### Discuss Location

Display “Pont du Gard Map” and point out the location of the Pont du Gard in southern France, northwest of Marseilles.

Ask students why the Romans would build an aqueduct in this location. Guide them to recall that France was once the Roman province of Gaul.

### Tell Students About Pont du Gard

Display the art resource or one of the photos of the Pont du Gard spanning the Gardon River from the UNESCO Pont Du Gard Gallery.

Tell students that the Pont du Gard is part of a large network of Roman aqueducts that provided water to the city of Nîmes. It is a three-story structure built in the first century *CE*. The aqueduct is 164 feet (fifty meters) tall and spans the Gardon River. Note that the river flows through a valley.

## Visit Pont du Gard

Display other photos from the “UNESCO Pont du Gard Gallery” and “Ancient Work of Art.”

As you display the photos, point out the following features:

- the pillars
- the arches and their eighty-two-foot (twenty-five-meter) gap (one of the largest in the Roman world)
- the water channel across the top
- the limestone blocks that form the bridge
- the breeze blocks and mortar that form the top of the structure

If time allows, you may wish to show students the 360° view from the water channel of the Pont du Gard.

Now ask students the following “looking questions” as you examine the photos:

- What is this?
  - » It is a Roman aqueduct, used to deliver water over distances.
- What shape repeats throughout this architecture?
  - » A rounded arch repeats.
- How do the arches differ at each level?
  - » They differ in size and scale.
- What materials were used for the aqueduct?
  - » The aqueduct is made of stone.
- How big is the aqueduct? What are some hints?
  - » It must be big because it crosses a river at a great height and has one of the largest arches found in the Roman world. It is fifty meters high and 360 meters long. (A meter is over one yard in length.).
- Why do you think the aqueduct has lasted for 1,900 years?
  - » It has lasted because it is made of stone and it was very carefully built.
- Do the size and design tell you anything about how long the Romans were convinced their civilization would last?
  - » By its size and excellent construction, the aqueduct is a statement by the Romans that they would last hundreds, if not thousands, of years. This piece of engineering is built as well as one of their famous temples.

# The Buildings of Rome

**The Big Question:** How was Rome similar to a modern city?

## Primary Focus Objectives

---

- ✓ Describe ancient Rome as a crowded and busy city. **(RI.3.2)**
- ✓ Explain what the Temple of Jupiter is and the significance of its location in Rome. **(RI.3.2)**
- ✓ Describe the activities that took place in Rome’s markets and the Forum. **(RI.3.2)**
- ✓ Understand the meaning of the following domain-specific vocabulary: *gladiator* and *marble*. **(RI.3.4)**

## What Teachers Need to Know

---

For background information, download the CKHG Online Resource “About Life in the Roman Empire”:

[www.coreknowledge.org/ckhg-online-resources](http://www.coreknowledge.org/ckhg-online-resources)

## Core Vocabulary (Student Reader page numbers listed below)

---

**gladiator, n.** a man in ancient Rome who fought another man or an animal to entertain the public **(64)**

*Example:* Gladiator fights were a popular sport in ancient Rome.

*Variation(s):* gladiators

**marble, n.** a kind of stone that is used in buildings and sculptures **(65)**

*Example:* The Romans used marble in buildings such as the Temple of Jupiter.

## Materials Needed

---

Use this link to download the CKHG Online Resources for this unit, where a link for a collection of photographs, “City Photos,” may be found:

[www.coreknowledge.org/ckhg-online-resources](http://www.coreknowledge.org/ckhg-online-resources)

## Introduce “The Buildings of Rome”

5 MIN

Ask students to recall where they left off with the story of Linus and Lucia, and remind them that these two characters are fictional. (Students will remember that Linus and Lucia were going to Rome with their grandfather. Grandfather taught them about Roman roads, bridges, and aqueducts.) Explain that in this chapter, Linus, Lucia, and Grandfather begin their stay in Rome. Point out that Rome was an exceptionally large city for its time.

Draw students’ attention to the Big Question.

**SUPPORT**—For students who are not familiar with modern-day urban life, show them some photographs of a typical large city. Be sure to preview pictures before displaying to the class to ensure the content is appropriate for your students.

As you look at photographs, ask students to observe the common features of large cities. What do they notice about the buildings? (*The buildings are tall and close together.*) What do they notice about the roads? (*They are often jammed with traffic and people.*)

As volunteers share their observations about the characteristics of modern cities, encourage them to look for these characteristics, or the ancient equivalent, as they read about Rome.

## Guided Reading Supports for “The Buildings of Rome”

20 MIN

When you or a student reads aloud, **always** prompt students to follow along. By following along, students may acquire a greater understanding of the content. Remember to provide discussion opportunities.

### “A Visit to Rome,” Pages 62–64

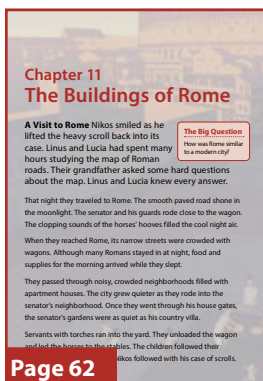

Invite a volunteer to read the section aloud. Scaffold understanding as follows:

**CORE VOCABULARY**—In the last paragraph, after the student reads the last sentence, review the phrase “chariot races” and the word *gladiator* to clarify the meaning of the sentence. Students will read more about chariot races and gladiators in Chapter 12.



Then, ask the following questions:

**LITERAL**—What was Rome like when Linus and Lucia arrived? What evidence is there in the text for your answer?

- » Noisy, busy, crowded. The text says there were “narrow streets crowded with wagons” and that there were “noisy, crowded neighborhoods.” The illustration on page 63 and the caption show many apartment buildings.

**EVALUATIVE**—How was the senator’s neighborhood different from the rest of the city? Why do you think there was a difference between the senator’s neighborhood and other parts of the city?

- » It was quiet. The senator was a patrician and was wealthy. He could afford to live in a more spacious, larger house away from the crowded apartment buildings.

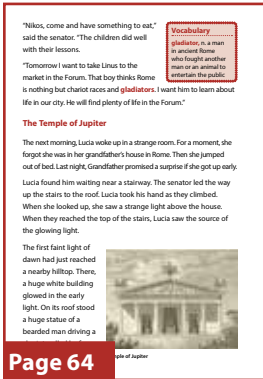

## “The Temple of Jupiter” and “The Marketplace,” Pages 64–65

Read aloud the two sections for students. Scaffold understanding as follows:

**CORE VOCABULARY**—After reading the fourth paragraph under the section “The Temple of Jupiter,” pause to discuss the definition of the word *marble*. Make sure students can distinguish between the building material referenced in the reader and the kinds of marbles students may be familiar and play with.

When you have finished reading, ask the following questions:

**LITERAL**—Using what you have read and the image of the Temple of Jupiter in the Student Reader, how would you describe this structure?

- » It is a very large building surrounded by marble pillars. It stands high above the city and captures the light in the early morning, making it appear to glow. On its roof are huge statues.

**EVALUATIVE**—Why might the Romans have built Jupiter’s temple on a hill?

- » As the king of the gods, Jupiter was the most important god. By building his temple high on a hill, it showed that he was most important by being above everything and everyone else. It also meant that he could look down on all of Rome to see what was happening. Also, it was probably easy for Romans to see his temple from many different places in the city.

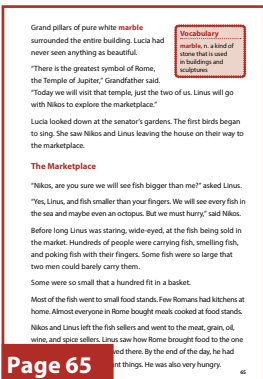

**LITERAL**—What other temples have you already read about?

- » Temple of Vesta and Temple of Janus

**INFERENTIAL**—What other gods or goddesses might you expect to find temples for in Rome?

- » Mars, Juno, and Saturn; students who completed the optional activity on the solar system in Chapter 2 may also mention Mercury and Venus.

**LITERAL**—Describe and name the marketplace that Linus and Niko visited. How is it the same as or different from the type of place from which your family buys food?

- » Linus and Niko visited the fish market. It was different from most markets that people go to today because it sold only fish. Other goods were sold in other markets.

**LITERAL**—Why did almost everyone in Rome buy meals cooked at food stands?

- » Few Romans had a kitchen in their home.

## “A Busy City,” Pages 66–67

Invite students to read the section silently to themselves. When they have finished reading, ask the following questions:

**LITERAL**—What did Lucia see when she gazed down at the Forum of Rome?

- » She saw people talking and shouting, buying and selling, walking, running, and standing still.

**INFERENTIAL**—The text says that Lucia and her grandfather “visited temples and theaters.” Do you think the theaters that they visited were like the modern-day theaters that you go to? Why or why not?

- » The theaters may have had some similarities, such as seats facing a stage. The theaters that Lucia and her grandfather visited were exclusively for plays. People visit theaters today usually to watch movies. Films and movies were not invented during the time of ancient Rome.

**EVALUATIVE**—As Lucia and her grandfather walked throughout the city of Rome, how did the people they saw provide an indication of how large and vast the Roman Empire was?

- » They saw people from many different provinces of the Roman Empire. There were Egyptians, Greeks, redheaded people from Gaul, and dark-skinned people from Africa.





## CHECK FOR UNDERSTANDING 5 MIN

Ask students to do one of the following:

- **Turn and Talk**—Ask a partner to answer the Big Question, “How was Rome similar to a modern city?”
  - » Key points students should cite include: Rome was noisy and crowded in places, with lots of people and large buildings. It had apartment buildings, theaters and other entertainment, and places for people to buy things. People living in Rome also came from many different places, not just Rome, as is the case in many modern cities.
- Choose one of the Core Vocabulary words (*gladiator* or *marble*), and say a sentence aloud using the word.

To wrap up the lesson, ask several students to share their responses.

## Additional Activities



Visit the Pantheon (L.3.6, SL.3.2)

30 MIN

Activity Page



AP 11.1

**Materials Needed:** Internet access.

Or

**Alternate Art Activity for the Pantheon:** If you do not have classroom access to the Internet, you can purchase the Core Knowledge Curriculum Series™ Art Resource packet for Grade 3, available at:

[www.coreknowledge.org/store](http://www.coreknowledge.org/store)

Use this art resource to guide students through the following activity.

**Background for Teachers:** Use this link to download the CKHG Online Resources for this unit, where specific links to information about the Pantheon may be found:

[www.coreknowledge.org/ckhg-online-resources](http://www.coreknowledge.org/ckhg-online-resources)

Prior to discussing the Pantheon with students, click on the “Wonders of the World Databank” link.

### Introduce the Pantheon

Remind students that the Romans built temples to worship their many gods: each god or goddess had his or her own temple. In the 100s CE, the Roman emperor Hadrian built a temple to worship all of the Roman gods in one place. This temple is called the Pantheon.

## Explore the Pantheon

Prior to discussing the Pantheon with students, display the art resource for the Pantheon, or use the specific online resource, “Pantheon at Dawn.”

Point out the architecture features: the pillars (which were influenced by Greek architecture) and the portico (a porch with a roof supported by pillars).

## Discuss Domes

Explain that in addition to pillars and arches, Roman architecture is also famous for its use of domes. Just like building bridges and aqueducts, building domes was a complex process. Behind the pillars and portico of the Pantheon is a building topped with a dome.

View the video, “Pantheon Dome.”

After viewing the video, discuss with students how skilled the Romans were as builders. Review the evidence the Romans left behind that supports this conclusion.

If time allows, you may also wish to view “Rome, Italy: the Pantheon by Rick Steves.”

In this tour of the Pantheon, Steves uses architectural terminology that students might not grasp, so if you show the video, you might want to pre-teach some of those terms or instruct students to focus on the images rather than the narration.

Use the following “looking questions” to focus students’ attention:

- Here is a photograph of the inside of a famous building built almost two thousand years ago by the ancient Romans. What shape is the building?
  - » It is circular with a dome, or hemisphere, for a roof.
- What are some of the geometric shapes that you see on the walls and the inside of the dome?
  - » Students should see rectangles, squares, and triangles, as well as a circle (the oculus) and an arch.
- The window in the center of the dome is called an oculus. Why do you think the builders added an oculus to the design?
  - » Answers will vary. The oculus is a source of light—an important one since there are no other windows—and natural lighting was more important in the days before electricity.



- Do you see the recessed panels on the dome? What happens to the size of these panels as they move closer to the oculus?
  - » They get smaller, because the dome is largest at the bottom and smaller as you go up toward the oculus.
- What do you think the building might have been used for?
  - » Answers will vary. Explain that the name *Pantheon* means “all the gods” in Latin, which suggests that the building was a shrine to all the Roman gods. Later it was used as a Christian church.
- Have you ever seen any other buildings that look like the Pantheon?
  - » Answers will vary. Students should understand that many American architects have been influenced by the Roman style of architecture in the Pantheon. Some buildings that reflect this influence include the U.S. Capitol, Thomas Jefferson’s Rotunda at the University of Virginia, many state government buildings, and many old, domed churches.

Distribute The Pantheon (AP 11.1), found in Teacher Resources (page 159). Have students label the parts of the Pantheon based on what they learned during their virtual visit.



### What Did the Forum Look Like? (L.3.6, SL.3.1)

15 MIN

Use this link to download the CKHG Online Resources for this unit, where the specific link for a photograph of the Roman Forum may be found:

[www.coreknowledge.org/ckhg-online-resources](http://www.coreknowledge.org/ckhg-online-resources)

Ask students to examine the photograph and speculate about what the Forum might have looked like before it became ruins.

Tell students that archaeologists have spent years studying the ruins of the Forum and imagining what it used to look like. Use the Online Resources link, “Roman Forum Animation” to play the animation that presents one possibility of what the Forum might have looked like.

In a class discussion, have students compare their speculations with the animation.

Activity Page



AP 11.2

**Materials Needed:** Sufficient copies of Domain Vocabulary: Chapters 8–11 (AP 11.2), found in Teachers Resources (page 160).

Distribute Domain Vocabulary: Chapters 8–11. Students should complete the activity by matching each Core Vocabulary term with its description. The page uses vocabulary and information from Chapters 8–11 with some review terms from Chapters 1–7.

# Gladiators and Chariot Races

**The Big Question:** How were the Colosseum and Circus Maximus similar, and how were they different?

## Primary Focus Objectives

---

- ✓ Recognize the Colosseum and understand its structure. (RI.3.2)
- ✓ Describe how the Colosseum was used. (RI.3.2)
- ✓ Describe the structure and uses of the Circus Maximus. (RI.3.2)
- ✓ Understand the meaning of the following domain-specific vocabulary: *Colosseum*, *arena*, and *chamber*. (RI.3.4)

## What Teachers Need to Know

---

For background information, download the CKHG Online Resource “About Gladiators and Chariot Races”:

[www.coreknowledge.org/ckhg-online-resources](http://www.coreknowledge.org/ckhg-online-resources)

## Core Vocabulary (Student Reader page numbers listed below)

---

**Colosseum, n.** a large stadium in ancient Rome (68)

*Example:* The Colosseum was used for gladiator contests and other events in ancient Rome.

**arena, n.** an area surrounded by seating for the public, where sports events are held (70)

*Example:* Thousands of Romans went to the arena called the Colosseum to watch gladiators fight.

*Variation(s):* arenas

**chamber, n.** a small space or room (70)

*Example:* The gladiators were kept in a chamber underneath the Colosseum.

*Variation(s):* chambers

## Introduce “Gladiators and Chariot Races”

5 MIN

Start by reading the title of this chapter, and review the meaning of the words *gladiator* and *chariot* by asking students to refer to their glossary.

Ask students to recall that Julius Caesar gained popularity with the people of Rome by staging elaborate games, sporting events, and festivals. Help them recall that Augustus also thought that games and festivals were important to the morale of the Romans. Tell students that in this chapter, which again is historical fiction, they will learn about two particular types of events as they read about Lucia, Linus, their grandfather, and Nikos visiting two different places in ancient Rome.

Draw students’ attention to the Big Question, and ask them to read to find out what the Colosseum and Circus Maximus were and what events took place there.

## Guided Reading Supports for “Gladiators and Chariot Races”

20 MIN

When you or a student reads aloud, **always** prompt students to follow along. By following along, students may acquire a greater understanding of the content. Remember to provide discussion opportunities.

### “Linus Gets Lost,” Pages 68–70

Scaffold understanding as follows:

**CORE VOCABULARY**—Note the term *Colosseum* that appears in red on page 68. Make clear that this term refers to a specific building in Rome. Direct students’ attention to the image of the Colosseum on page 69 of the Student Reader. Ask students to describe what they see, directing their attention in particular to the structure of the building. Point out the crowds of people seated around the sides of what appears to be some sort of event. Read the caption and explain that this building or arena was called the Colosseum. Note that a similar word—*coliseum*—is used in English to refer generally to a large stadium or theater. A number of cities in America have sports stadiums that have the word *coliseum* in their names.

**Read the entire section aloud to students, paragraph by paragraph. Continue to scaffold understanding, and as you come to each Core Vocabulary word, pause to discuss its meaning.**

**CORE VOCABULARY**—In the second paragraph on page 70, call out the term *arena*. Explain that this word describes a type of building. Ask: What is an example of an arena that you have just been reading about? (*the Colosseum*)

**CORE VOCABULARY**—Direct students’ attention to the last paragraph and the word *chambers*. Provide students with the definition from the page.

**Chapter 12**  
**Gladiators and Chariot Races**

**Linus Gets Lost** “It appears my grandson has a poor memory,” said Grandfather. “I told him not to go into the underground passageway. Yet that is exactly where he has gone.”

**The Big Question**  
How were the Colosseum and the Circus Maximus similar, and how were they different?

**Vocabulary**  
Colosseum, n. a large stadium or arena; Rome

Lucia started down the passageway to the underground part of the Colosseum. She thought maybe she could help find Linus, even though she did not like the look of the dark passageway.

Grandfather called her back. “No, Lucia. Don’t you go looking for your brother,” he said. “I will speak to the commander of the sailors. We may need some help to find him down there. Until then, Linus can learn just how lost he can get. Perhaps it will help his poor memory.”

Grandfather turned to Nikos. “Tell the commander of the sailors

**Page 68**



**Page 69**

Nikos began climbing the hundreds of steps to the top of the Colosseum. The senator took Lucia's hand and led her onto the spiral floor of the Colosseum.

"Lucia, I want you to understand how they built this great arena," said Grandfather. "It is the finest in Rome. It has seating for fifty thousand people. The round outside wall is built like an aqueduct with arches of stone stacked on each other. Arches also support the inside rows of seats, which look like a giant oval stairway.

"Look all around the top of the arena. There are one thousand sailors from the Roman navy up there. They are waiting for the command to roll out the awning. The awning is a giant canvas roof that shades the seats from the sun.

"There are many passageways under the floor of the arena. They connect dozens of chambers. Some of these rooms hold wild animals. Others are for the gladiators. One passageway connects the gladiator school to the arena. When it is time for a big gladiator fight, the gladiators are led out of one door, and the animals out of another."

**Linus Meets the Gladiators**

Linus was very sure of two things. He was very sure he was lost. He was also very sure that he wanted to get out of the underground passages.

...wing sound. It was a sound that a

**Vocabulary**  
**arena**, an area surrounded by seating for the public, where sports events are held  
**chamber**, a small space or room

**Page 70**

**After reading, ask the following questions:**

**LITERAL**—Where has Linus disappeared to?

- » The underground part of the Colosseum.

**LITERAL**—What are the chambers under the Colosseum used for?

- » There are many different rooms; there are gladiators in some and wild animals in others. There is even a place for a gladiator school.

**INFERENTIAL**—What do you think gladiators might learn or practice in gladiator school?

- » They probably practice fighting one another and even fighting wild animals.

**EVALUATIVE**—Do you think Lucius is in any real danger?

- » Students should understand that although wild animals were kept in the underground chambers, the animals were not running around loose. Furthermore, if Lucius were in any real danger, his grandfather would not be so relaxed about finding him.

**LITERAL**—What architectural form was used to construct the Colosseum?

- » Stone arches like those used in aqueducts supported the walls and the inside rows of seats in the Colosseum.

**EVALUATIVE**—Which details in the story tell you that the Colosseum was a giant structure?

- » The Colosseum had hundreds of steps to the top, had seating for fifty thousand people, had walls built like aqueducts, and had dozens of chambers under the floor.

**“Linus Meets the Gladiators,” Pages 70–73**



The Colosseum could seat tens of thousands of spectators.

Linus held his breath until he heard the sound again. This time it was louder—much louder. He was sure it was a very large animal.

Linus ran back down the dark passageway. He didn't know he could run so fast. He kept running until he saw a stairway. At the top of the stairway, he saw the sky.

A moment later, Linus was blinking at the bright sunlight in a sand-covered arena. He looked around. He was surrounded by fierce-looking warriors.

They were wearing helmets and carrying swords. They were covered with sweat and dust. They were looking at him.

Someone shouted, "Get that boy!"

Linus ran down the stairs and back into the dark passageway. He kept running.

**Page 71**

...is at the top of the Colosseum. He ...r's message to the naval commander.

**Read the section aloud, using expression, pacing, and intonation to create suspense and drama. After reading, ask the following questions:**

**LITERAL**—What happens when Linus runs away from the sound of a growling animal?

- » He runs into the arena where the gladiators are.

**LITERAL/INFERENTIAL**—How are the gladiators dressed? Why?

- » The gladiators wear helmets for protection and carry swords, which they use in their fights.

A moment later, the great awning began to unroll. Lucia felt better. Soon the sailors would help find Linus, and she could stop weeping.

Suddenly, Linus ran through a doorway on the other side of the arena. He kept running until he reached his grandfather. He hugged him and would not let go. Linus was very pale.

"I'm glad you could join us, boy. We were just going to explore the underground chambers and visit the gladiator school." Grandfather teased.

Grandfather smiled and said, "Lucia, as much as I love this arena, I never come to the gladiator contests or the wild animal fights. I don't like killing, even though many Romans do. I'd rather watch the chariot races at the Circus Maximus."



Page 72 Let the wild animal fight.

**LITERAL**—How does Linus find his grandfather?

- » He runs away from the gladiators and crashes into his grandfather.

**EVALUATIVE**—How does Linus feel in this part of the chapter? How do you know?

- » He feels scared. He runs as fast as he can away from the animal and then from the gladiators. When he finds his grandfather, he is pale and hugs his grandfather and does not let go.

**LITERAL**—Which sport does Grandfather prefer: gladiator fights or chariot races? Why?

- » He prefers chariot races because he does not like the killing that happens in gladiator fights.

"So would I, Grandfather," said Linus. "This place scares me. Could we leave here, please? Right now!"

"We will wait here for Nikos," said Grandfather. "While we are waiting, think of a special way to thank him for climbing to the top of the Colosseum to help find you. You will also tell your sister you are sorry."

Grandfather signaled to Nikos and pointed to Linus. Nikos spoke to the commander. The naval commander saluted the senator. Nikos started the long walk back down.

**Circus Maximus and Chariot Races**

On the way to the Circus Maximus, Nikos carried Linus on his shoulders, and Lucia held her grandfather's hand. It was a beautiful day, but the streets were almost empty.

"Where is everyone?" asked Lucia.

At that moment, a great roar filled the air. It was a lot like thunder. Another great roar sounded, even louder than the first one.

Grandfather laughed. "I'm certain that not everyone in Rome is in the Circus Maximus. But the Circus Maximus can seat 250,000 people. It is much larger than the Colosseum, with a huge oval racetrack. The chariot races are the most exciting show in Rome.

"They race twelve chariots, each pulled by four fast horses. The racetrack is a dangerous place. The drivers and the horses must be careful, or terrible accidents can happen."

Page 73 73

**"Circus Maximus and Chariot Races," Pages 73–75**

**Invite a volunteer to read the sections aloud. Then, ask the following questions:**

**INFERENCE**—Why are the streets almost empty as Nikos, Linus, Lucia, and her grandfather walk to the Circus Maximus?

- » Most of the people who would be on the streets are in the vast Circus Maximus.

**LITERAL**—What was the Circus Maximus? How was it used?

- » The Circus Maximus was a long oval racetrack with seating for 250,000 people. Chariot races were held at the track.

Grandfather looked at Nikos. "Well, it's time to watch the races. Are you ready?"

Nikos was so excited he could hardly speak.



Page 74 entertainment.



Page 75 75



## CHECK FOR UNDERSTANDING 5 MIN

Ask students to do one of the following:

- **Turn and Talk**—Ask a partner to answer the Big Question, “How were the Colosseum and Circus Maximus similar? How were they different?”
  - » Key points include that both were large stadiums or arenas used for sporting events in ancient Rome. Each could seat thousands of people, but the Circus Maximus was larger. The Colosseum was used for gladiator fights. The Circus Maximus was used for chariot races.
- Choose one of the Core Vocabulary words (*Colosseum*, *arena*, or *chamber*), and say a sentence aloud using the word.

To wrap up the lesson, ask several students to share their responses.

## Additional Activities

### Androcles and the Lion (RL.3.1)

30 MIN

Activity Page



AP 12.1

**Materials Needed:** Sufficient copies of the “Androcles and the Lion” (FE 1), found in the CKHG Online Resources for this unit; and Androcles and the Lion (AP 12.1), found in Teacher Resources (page 161).

Distribute copies of the story and the activity page. (FE 1 and AP 12.1). Have students work by themselves or with a partner to read the story and answer the questions.

After students have completed the activity, briefly discuss the story as a class. Ask: Do you think a story like this could actually have happened in ancient Rome? Why or why not? (*Students should recognize the story as a folktale describing events that were not likely to happen. However, do point out to students that certain aspects of the story are based on events that did, in fact, take place during ancient Roman times. For example, Roman soldiers did enslave some people from Africa, who were punished if they attempted to escape. Enslaved people were sometimes forced to fight wild animals as gladiators in the Colosseum. The folktale of “Androcles and Lion” has been passed down through time and is often attributed to Aesop, as one of Aesop’s Fables. However, the story is said to have been told first by a person who witnessed a gladiator fight at the Colosseum.*)



**Background for Teachers:** Prior to taking students on a virtual field trip to the Colosseum, use the CKHG Online Resources for this unit, where specific links with background about the Colosseum may be found:

[www.coreknowledge.org/ckhg-online-resources](http://www.coreknowledge.org/ckhg-online-resources)

### **Introduce the Colosseum**

Display a photograph of the ruins of the Colosseum. Remind students that the Colosseum was used for gladiator fights and other events, such as recreations of famous battles.

Point out the Colosseum's architectural features, such as the arches, steps, and seating.

### **Visit the Ruins of the Colosseum**

Use the Online Resources link to find a video about the Colosseum's architecture. Show the first two minutes of the following:

- Inside Roman Architecture: Time Scanners: Colosseum

Note that the description of the events that took place in the Colosseum that occurs from 0:30 to 0:50 is graphic and should be previewed before sharing with your students.

### **Explore the Ancient Colosseum**

Organize students in pairs or trios. Use the Online Resources link to find the specific link to:

- The Colosseum: Building the Arena of Death

After students have explored the Colosseum, debrief as a class by inviting students to share what they found most interesting or impressive about the ancient Colosseum.



# Pompeii

**The Big Question:** What do the ruins of Pompeii tell us about life in ancient Rome?

## Primary Focus Objectives

---

- ✓ Explain the effect of the eruption of Mount Vesuvius in 79 CE on the people of Pompeii. (RI.3.2)
- ✓ Explain how the eruption of Mount Vesuvius has aided our understanding of daily life in the Roman Empire. (RI.3.2)
- ✓ Describe daily life in Pompeii in 79 CE. (RI.3.2)
- ✓ Understand the meaning of the following domain-specific vocabulary: *ruin, pollution, preserve, volcano, Earth's crust, debris, archaeologist, trade, mosaic, and amphitheater*. (RI.3.4)

## What Teachers Need to Know

---

For background information, download the CKHG Online Resource “About Pompeii”:

[www.coreknowledge.org/ckhg-online-resources](http://www.coreknowledge.org/ckhg-online-resources)

## Core Vocabulary (Student Reader page numbers listed below)

---

**ruin, n.** what remains of an old building or structure (76)

*Example:* Today, the Colosseum is a ruin.

*Variation(s):* ruins

**pollution, n.** something that makes land, water, or air dirty and unsafe (76)

*Example:* Ruins, such as the Colosseum, have been damaged by pollution from cars.

**preserve, v.** to keep or save (78)

*Example:* Historians and scientists work to preserve ancient buildings such as the Pantheon.

*Variation(s):* preserved

**volcano, n.** a mountain that has cracks leading to openings deep inside the earth from which hot, melted rock may sometimes erupt (78)

*Example:* The eruption of a volcano destroyed the Roman city of Pompeii.

*Variation(s):* volcanoes

**Earth's crust, n.** the hard, thick outer layer of Earth's surface (78)

*Example:* When a volcano erupts, melted rock pushes through cracks in Earth's crust.

**debris, n.** the pieces left over after something has been destroyed (78)

*Example:* When a volcano erupts, debris from the mountain is spit into the air.

**archaeologist, n.** an expert in the study of ancient people and the objects from their time period that remain (80)

*Example:* The archaeologist dug carefully through the ruins of Pompeii to learn about ancient Roman life.

*Variation(s):* archaeologists

**trade, v.** to buy and sell goods (80)

*Example:* Pompeii's location near the Bay of Naples made it a good place for people to trade.

*Variation(s):* trading, traded

**mosaic, n.** artwork made of many small pieces of colorful stone or tile (82)

*Example:* The floor of the Pompeian home was covered with a colorful tile mosaic.

*Variation(s):* mosaics

**amphitheater, n.** an outdoor round or oval building that has an open space surrounded by rising rows of seats (82)

*Example:* The people of Pompeii went to see gladiator fights in an amphitheater.

*Variation(s):* amphitheaters

## THE CORE LESSON 25 MIN

### Introduce "Pompeii"

5 MIN

Recall for students that the story of Linus and Lucia is fictional. But explain that there is nothing in the story that is implausible. Ask students how the writer knew about life in ancient Rome. (*Written records and artifacts from ancient Rome provide this kind of information. If students say the writer read a book, push them to think about how the writer of the book knew about ancient Rome.*) Then, ask students to think about why it is hard for people living today to know what it was like to live in ancient Rome.

Introduce the Big Question, and tell students that in this chapter they will read about a terrible disaster that occurred in a place known as Pompeii during ancient Roman times that has allowed people today to learn a lot about Roman life.

When you or a student reads aloud, **always** prompt students to follow along. By following along, students may acquire a greater understanding of the content. Remember to provide discussion opportunities.

“Ruins,” Pages 76–78

Scaffold understanding as follows:

**CORE VOCABULARY**—Introduce the term *ruin*, which occurs in the title and the second paragraph of this section. Ask students which ruins have they already seen or visited during their study of ancient Rome. Direct students to the photo of the ruins, which appears on pages 76–77 of the Student Reader. Ask students to describe what they see, and explain that these are photos of ruins from ancient Pompeii that can still be seen and visited today.

**Ask a student volunteer to read aloud the paragraphs of this section. As the volunteer comes to the terms *pollution* and *preserved*, review the definitions that appear on the Student Reader pages.**

**CORE VOCABULARY**—Direct students’ attention to the last paragraph on page 76 and the term *pollution*. Read the definition, and make clear that the kind of pollution that has harmed the Roman ruins is pollution of the air.

**CORE VOCABULARY**—Point out the term *preserved* in the first paragraph on page 78. Make clear that the ruins we can see today have been preserved.

Then ask the following questions:

**LITERAL**—Why have most Roman ruins been damaged?

- » Time, weather, earthquakes, fires, wars, and air pollution have all damaged the bridges, roads, buildings, and other structures created by the Romans. People have also sometimes taken pieces of the ruins to keep as souvenirs.

**CHALLENGE**—What kinds of things might people learn by studying Roman ruins?

- » It depends upon what the ruins are and what’s left. It might be possible to study what buildings were made of and how they were made. If parts of ancient pottery are found or even jewelry, it might be possible to tell more about how the people lived.

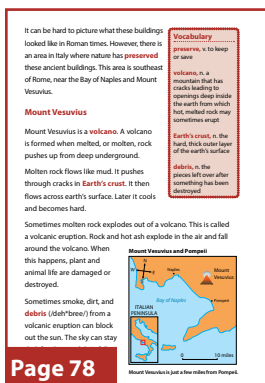
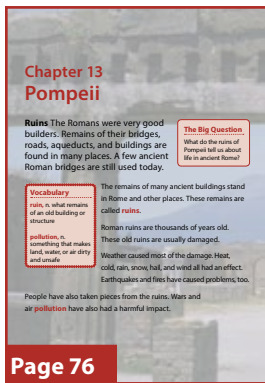

## “Mount Vesuvius” and “Mount Vesuvius Buries Pompeii,” Pages 78–79

**Mount Vesuvius Buries Pompeii**

Mount Vesuvius erupted on August 24, 79 CE. Rock and ash exploded from the volcano. The debris fell like rain for two days. The town of Pompeii (pomp'ey) was six miles away from Mount Vesuvius. Hot gas killed many people without warning. Then rock and ash from the eruption buried the town. Pompeii disappeared under twenty-three feet of volcanic debris.

The debris damaged every building in Pompeii. That same debris preserved Pompeii as it was at the moment the disaster struck. The town remained buried and forgotten for almost 1,700 years.



**Page 79**

**Scaffold understanding as follows:**

 **CORE VOCABULARY**— Preview the terms *volcano*, *Earth's crust*, and *debris*, and explain how they are related. Draw a diagram on the board or chart paper, and refer to the picture on page 79 of the Student Reader to help illustrate these terms.

**Now ask student volunteers to read aloud the paragraphs of these two sections.**

**Note:** Students using a curriculum based on the *Core Knowledge® Sequence* will have already studied about volcanoes and Earth's crust in Grade 1.

**After students have finished, ask the following questions:**

**LITERAL**—What is Mount Vesuvius?

» It is a volcano.

 **LITERAL**—Using the map on page 78, can you describe where Mount Vesuvius is located in relation to Pompeii? How far away is it?

» The map shows that Pompeii is about six miles south of Mount Vesuvius.

**LITERAL**—How were the people of Pompeii affected when Mount Vesuvius erupted in the year 79 CE?

» The hot gas from the volcano killed many people. The rock and ash buried the people and town. Pompeii lay buried and forgotten for nearly 1,700 years.

**LITERAL**—How did the eruption of Vesuvius both destroy and preserve Pompeii?

» The eruption damaged and buried the city and killed the people, but the debris froze Pompeii at that moment in time.

## “Pompeii Is Found” and “Daily Life in Pompeii,” Pages 80–81

**Pompeii Is Found**

The buried town was found in 1763. Since then, people from all over the world come to explore Pompeii. Some people come to search for statues or gold coins. Some people come to study Roman buildings. Others want to find out about volcanic eruptions. Everyone wants to know what happened on that awful day. It took years of digging to find certain answers.

Today, more than half of Pompeii has been dug up. This work is done by experts called archaeologists. They are still digging slowly and carefully. While they want to find out more, they do not want to do any more harm to the ancient city's remains.

**Daily Life in Pompeii**

Pompeii has taught us much about the Roman people. The buildings of Pompeii are filled with things people used every day. These things help us understand how ancient Romans lived.

Pompeii was a town of about twenty thousand people. The town was built next to a river. The river flowed into the Bay of Naples. Ships from all over the Roman world brought goods that could be traded in Pompeii.

The people of Pompeii traded wine, olive oil, grain, pottery, and wool cloth. In the busy marketplace, farmers sold fruits and vegetables. Politicians made speeches. Poets shared their latest poems.

**Page 80**

**Scaffold understanding as follows:**

**CORE VOCABULARY**—Preview the words *archaeologist* and *trade* as students refer to the definitions in the Student Reader on page 80. Help students recognize that much of what we know about ancient Rome and the ancient world in general comes from the work of archaeologists.



**Have students read the sections on pages 80–81 to themselves or with a partner.**

**Then ask the following questions:**

**LITERAL**—Why has the destruction of Pompeii helped archaeologists understand more about life in the Roman Empire?

- » Although the city was destroyed, the buildings, objects, and bodies of people and animals were preserved under layers of ash and mud until scientists could dig them up and study them.

**EVALUATIVE**—The text says that Pompeii had more than two hundred places to eat and drink. What do you think archaeologists found that led to this conclusion?

- » Possible answers: They found dishes and utensils that suggested people were gathering at that spot to eat or drink. Other signs might be large amounts of utensils for storing or preparing food for large groups.

## “The People of Pompeii,” Pages 82–83

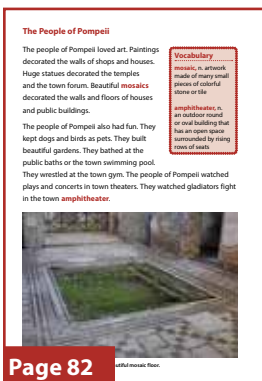

**Scaffold understanding as follows:**

**CORE VOCABULARY**—Read the first paragraph in the section aloud. When you come to the term *mosaics*, pause to note the definition provided. Direct students’ attention to the image, which shows a mosaic floor, to help illustrate the concept.

**CORE VOCABULARY**—Read the second paragraph in the section aloud. Note the last word, *amphitheater*. Help students recognize that the Colosseum, about which they’ve learned so much, is an example of an amphitheater.

**When you have finished reading the rest of the section, ask the following questions:**

**INFERENCE**—How do we know that the people of Pompeii loved art?

- » Archaeologists have found evidence that private homes were often decorated with art.

**INFERENCE**—What findings have led archaeologists to conclude that the people of Pompeii had fun?

- » Archaeologists have found evidence that the people of Pompeii kept pets, built gardens, visited town swimming pools, and attended concerts and public exhibitions.

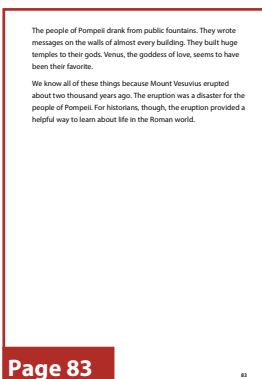

**INFERENTIAL**—Can you describe three characteristics of the people of ancient Pompeii?

- » Possible answers: They traded wine, olive oil, pottery, wool cloth, and grains. They went to the marketplace, where they sold or bought things. They loved art; the walls of their buildings were decorated with paintings and mosaics. They had pets and beautiful gardens. They enjoyed plays, concerts, and gladiatorial fights. They had public drinking fountains and temples honoring their gods.

**EVALUATIVE**—How was life in Pompeii similar to our lives today?

- » The people of Pompeii had restaurants and shops like we do today. They also kept pets, had swimming pools, and used public drinking fountains like we do today.

## Timeline

---

- Show students the Chapter 13 Timeline Image Card. Read and discuss the captions, making particular note of any dates.
- Review and discuss the Big Question, “What do the ruins of Pompeii tell us about life in ancient Rome?”
- Post the image card as the ninth image on the Timeline, under the date referencing 100 *BCE*–99 *CE*; refer to the illustration in the Unit 2 Introduction for further guidance on the placement of each image card to the Timeline.



### CHECK FOR UNDERSTANDING 5 MIN

**Ask students to do one of the following:**

- **Turn and Talk**—Ask a partner to answer the Big Question, “What do the ruins of Pompeii tell us about life in ancient Rome?”
  - » Key points students should cite include: They ate in restaurants. They had craftspeople, bakers, builders, and bankers. They decorated their homes and businesses with fine art. They kept pets, created gardens, used public baths and swimming pools, attended the theater, watched sporting events, used public drinking fountains, left graffiti, and built temples.
- Choose one of the Core Vocabulary words (*ruin, pollution, preserve, volcano, Earth’s crust, debris, archaeologist, trade, mosaic, or amphitheater*), and say a sentence aloud using the word.

To wrap up the lesson, ask several students to share their responses.

## Additional Activities



### Virtual Field Trip: Pompeii (SL.3.2)

30 MIN



#### Plan Your Trip

Prior to taking students on the virtual field trip, use this link to download the CKHG Online Resources for this unit, where the links specified below may be found:

[www.coreknowledge.org/ckhg-online-resources](http://www.coreknowledge.org/ckhg-online-resources)

- Gallery: Archaeological Areas of Pompeii, Herculaneum, and Torre Annunziata

You can use any image in this gallery, but you may want to focus especially on the images that show the interior of Pompeii buildings, such as images 16–18, images 28–30, and images 34 and 36.

- Pompeian Pictures

This site has photographs organized by region of the city and by type of structure. Consider focusing on the arches, baths, and public buildings of Pompeii.

- Google Street View: Pompeii

The items with the yellow icons provide opportunities to virtually explore specific ruins in Pompeii, such as the interior and exterior of the amphitheater, giving the sense of actually walking around the ancient city.

Using these sites, create a list of specific features you want your students to explore—those suggested above, or others that you identify in your own explorations.

#### Visit Pompeii

Tell students that they are now going to “visit” Pompeii as tourists.

Before students proceed to the tour, review briefly with students what happened to Pompeii—the explosion of Mount Vesuvius and the resulting destruction of the town.

Using the links and plans you have made, conduct your “tour” of Pompeii for students. As you navigate through the city, point out the features you noted when you planned the tour. Ask students to point out anything that catches their eyes, as well. Ask students to imagine themselves living in these spaces as residents of Pompeii did hundreds of years ago.



## Pompeii Diary (W.3.3)

30 MIN

Have students assume the role of an archaeologist studying the ruins of Pompeii. Have them write a diary entry describing life in Pompeii using the details from Chapter 13 of the Student Reader.

## From Pliny the Younger's *Letters to Tacitus*

30 MIN

**Materials Needed:** Sufficient copies of From Pliny the Younger's, *Letters to Tacitus* (NFE 1); use this link to download the CKHG Online Resources for this unit, where the specific link to the nonfiction excerpt may be found:

[www.coreknowledge.org/ckhg-online-resources](http://www.coreknowledge.org/ckhg-online-resources)

In this primary source document, Roman writer Pliny the Younger describes the eruption of Mount Vesuvius and the destruction of the city of Pompeii. As a primary source document, the language may prove too difficult for many third graders.

We include it here in the event that you choose to use it as a CHALLENGE activity. You may also decide to read the document aloud in a very scaffolded way as students follow along. Possible questions include the following:

**LITERAL**—What is the “cloud” that Pliny reports seeing in the first letter?

» It is the aftermath of the eruption of Mount Vesuvius.

**LITERAL**—What killed Pliny the Elder, according to this letter?

» He was killed by the effects of gas and flame, which suffocated him.

**LITERAL**—What were the effects produced by the eruption described in these letters?

» The eruption caused the seas to retreat and also become very wavy and “boisterous.” It caused rocks and other debris to rain down from the sky. It also caused ash to fall and explosions to occur.

**LITERAL**—What explains the “thick darkness” that Pliny the Younger describes?

» The heavy ash that fell from the volcano blocked out the sun and produced total darkness.

**LITERAL**—Why did Pliny the Younger survive the eruption?

» He was apparently far enough away from the flames and explosions, which seemed to be what killed many people.



# The Romans and the Christians

**The Big Question:** Why was Christianity considered to be dangerous to Rome?

## Primary Focus Objectives

---

- ✓ Identify what *Pax Romana* was. (RI.3.4)
- ✓ Explain why the Romans persecuted the early Christians. (RI.3.2)
- ✓ Describe the effects of persecution on the early Christians. (RI.3.2)
- ✓ Understand the meaning of the following domain-specific vocabulary, *persecute*, and of the phrase “religious belief.” (RI.3.4)

## What Teachers Need to Know

---

For background information, download the CKHG Online Resource “About the Persecution of Christians”:

[www.coreknowledge.org/ckhg-online-resources](http://www.coreknowledge.org/ckhg-online-resources)

## Core Vocabulary (Student Reader page numbers listed below)

---

**persecute, v.** to treat people cruelly and unfairly (88)

*Example:* It was common for Roman officials to persecute Christians.

*Variation(s):* persecutes, persecuted, persecution

**persecution, n.** cruel and unfair treatment of a group of people

**“religious belief,” (phrase),** an idea about gods or faith that someone accepts as true (88)

*Example:* A key religious belief of Christians is that there is only one god.

*Variation(s):* religious beliefs

## Introduce “The Romans and the Christians”

5 MIN

Tell students that the last few lessons have been about the structures that were built during the Roman Empire and the way that people of the empire lived. Ask students to quickly review some of the things they’ve learned about each of these topics. Then tell them that in this chapter, they will read more about the social conditions during the two hundred years following Augustus’s rule.

Explain to students that this chapter also uses a historical fiction approach in which they will meet some new fictional characters, a boy named Luciano and his teacher, who live in Rome during modern times. Luciano and his teacher are imaginary characters, but the events in Roman history that Luciano is learning about actually happened during the time the Roman Empire existed.

Invite students to share what they remember about the worship of the Roman gods and goddesses. Explain that during the Roman Empire, a new religion—Christianity—developed and spread through the empire. Introduce the Big Question, and ask students why Roman leaders might have felt threatened by a new religion.

**Note:** Students using a curriculum based on the *Core Knowledge® Sequence* will have already studied about the start of Christianity, as well as other world religions, in Grade 1.

## Guided Reading Supports for “The Romans and the Christians”

20 MIN

When you or a student reads aloud, **always** prompt students to follow along. By following along, students may acquire a greater understanding of the content. Remember to provide discussion opportunities.

### “Luciano Is Embarrassed” and “Homework for Luciano,” Pages 84–86

Read the title of the first section, clearly pronouncing the character Luciano’s name (/loo\*chee\*ah\*noe/). Next, have students read the two sections to themselves. When students have finished reading, ask the following questions:

**LITERAL**—What was the *Pax Romana*? When did it happen?

» The great Roman peace; in the early days of the empire.

Chapter 14  
The Romans and the Christians

**Luciano Is Embarrassed** It was the year 2016 in the city of Rome. The teacher looked around the classroom and began the lesson: “After he defeated Antony and Cleopatra, Octavian was the ruler of the Roman world.”

The teacher continued: “Octavian allowed the Senate to name him Augustus. He also liked the titles ‘First Citizen of Rome’ and ‘Father of Rome.’ He never allowed the Senate to name him king. But it did not matter. The Roman Republic was gone forever.”

“Augustus was the first Roman emperor, even though he never admitted it. Emperor ruled in Rome for the next five hundred years. They ruled in Constantinople for one thousand years after that.”

The teacher turned to one of the students, “Luciano, who was Octavian?” All the students turned to look at Luciano (/loo\*chee\*ah\*noe/). “Timothy,” Luciano said, “I wasn’t listening. I was looking through the mbarrassed.”

**The Big Question**  
Why was Christianity considered to be dangerous to Rome?

Page 84



## INFERENTIAL—What do you think life was like during the *Pax Romana*?

- » Students should recognize that peace is a time without war. They might also recognize that trade and wealth increase during peacetime.

### “The Great Roman Peace,” Pages 86–87

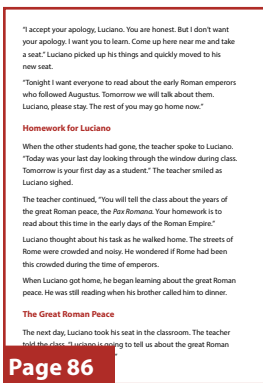

Read this section aloud. Encourage students to confirm their predictions about life during the *Pax Romana*. When you are finished, ask the following questions:

**LITERAL**—How long during the Roman Empire did the *Pax Romana* last?

- » two hundred years

**EVALUATIVE**—Were your predictions about the *Pax Romana* correct? Now that you know more, how could you correct your predictions?

- » Student responses should accurately reflect the facts they have encountered in the Student Reader.

### “The Early Christians,” Pages 87–88

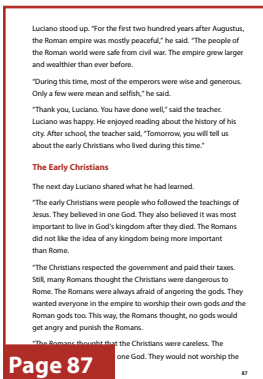

Read “The Early Christians” aloud. After reading this section, ask the following questions:

**LITERAL**—How can we describe the beliefs of the early Christians?

- » They believed that there was only one god and that the most important thing was to live in God’s kingdom after death.

**LITERAL**—Why were the Romans afraid of the Christians?

- » The Romans did not like the Christian belief in a kingdom greater than Rome, and they worried that Christians would anger the Roman gods.

**LITERAL**—What kind of religious freedom did Romans allow people in their empire?

- » They allowed people to worship whatever gods they chose, as long as they also worshiped the Roman gods.

## "Persecution," Pages 88–89

### Scaffold understanding as follows:

**CORE VOCABULARY**—Preview the term *persecuted* in the second paragraph of this section. Provide the definition, and explain that the noun form of this word is *persecution*.

**CORE VOCABULARY**—Also, note the phrase “religious beliefs” in the second paragraph. Note that the term is made of two words with which students are familiar. Have a volunteer read aloud the definition, and invite students to give examples of religious beliefs they have learned about in this unit. (Example: Romans believed that the gods were deeply involved in their lives.)

Then invite a volunteer to read “Persecution.” After reading is complete, ask the following questions:

**EVALUATIVE**—Why did the Romans persecute Christians?

- » The Christians believed in only one god and refused to worship the Roman gods. This made the Romans afraid that their own gods would become angry.

**LITERAL**—What did the Romans do to persecute the Christians?

- » Romans blamed disasters on the Christians; they put Christians in prison or killed them; they made them face wild animals in amphitheaters like the Colosseum.

**EVALUATIVE**—Why did the number of Christians continue to grow?

- » The number of Christians kept growing because Christians welcomed poor people and enslaved people and promised them a better life in the next world.

Roman gods. The Romans thought the Christians might anger the other gods. Then the whole human race would be in trouble.”

**Vocabulary**  
persecute, to treat people cruelly and unfairly  
“religious beliefs”  
Beliefs are ideas about gods or faith that someone accepts as true.

**Persecution**  
The teacher smiled brightly. “Thank you, Lucians. You did a fine job again today.”  
The teacher turned to the class. “The Romans persecuted the Christians because of their religious beliefs. Whenever something bad happened in Rome, the Romans blamed the Christians.”



**Page 88** while Rome burned around him.

“For example, there was a terrible fire in 64 C.E. Large areas of Rome were destroyed. The emperor Nero blamed the Christians. Nero was a selfish man, though. According to legend, he cared so little about Rome that he played a musical instrument called a lyre while the city burned. Today we have an expression, “tiddling while Rome burns.” It means paying no attention to great disasters happening around you.”

“At times the Christians were treated as criminals. They were put in prison or killed. Sometimes Christians were made to face wild animals in the Colosseum.”

“The Romans persecuted the Christians for many years. It was dangerous to be a Christian. Still, the number of Christians continued to grow. This is because the Christians welcomed poor people and enslaved people. Christians promised a better life in the next world, after death. This was appealing to those who suffered in the Roman world.”



**Page 89** a person such as the Colosseum. Besides, this is a form of entertainment.

## Timeline

- Show students the Chapter 14 Timeline Image Card. Read and discuss the captions, making particular note of any dates.
- Review and discuss the Big Question, “Why was Christianity considered to be dangerous to Rome?”
- Post the image card as the tenth image on the Timeline, under the date referencing 100 BCE–99 CE; refer to the illustration in the Unit 2 Introduction for further guidance on the placement of each image card to the Timeline.



## CHECK FOR UNDERSTANDING 5 MIN

**Ask students to do one of the following:**

- **Turn and Talk**—Ask a partner to answer the Big Question, “Why was Christianity considered to be dangerous to Rome?”
  - » Key points students should cite include: Christians refused to worship the Roman gods; Christianity offered alternatives to poor and enslaved people.
- Choose one of the Core Vocabulary words (persecute or “religious belief”), and say a sentence aloud using the word.

To wrap up the lesson, ask several students to share their responses.

## Additional Activities

**Domain Vocabulary: Chapters 12–14** (L3.6)

**30 MIN**

Activity Page



AP 14.1

Distribute Domain Vocabulary: Chapters 12–14 (AP 14.1) found in the Teacher Resources section (page 162). Direct students to complete the crossword puzzle based on what they have learned so far about ancient Rome. This activity page may also be assigned for homework.

# The Decline of the Roman Empire

**The Big Question:** What did Diocletian do to help prevent the total collapse of the Roman Empire?

### Primary Focus Objectives

---

- ✓ Identify some of the causes that led to the decline of the Roman Empire. (RI.3.2)
- ✓ Describe the barbarians and understand their role in the decline of the Roman Empire. (RI.3.2)
- ✓ Identify Diocletian. (RI.3.2)
- ✓ Understand the meaning of the following domain-specific vocabulary: *assignment*, *decline*, *corrupt*, *pillage*, and *collapse*. (RI.3.4)

### What Teachers Need to Know

---

For background information, download the CKHG Online Resource “About the Decline of the Western Empire”:

[www.coreknowledge.org/ckhg-online-resources](http://www.coreknowledge.org/ckhg-online-resources)

### Core Vocabulary (Student Reader page numbers listed below)

---

**assignment, n.** a task or job given to someone (90)

*Example:* Luciano learned to like the assignments about Roman history that his teacher gave him.

*Variation(s):* assignments

**decline, v.** to grow weaker (90)

*Example:* After the *Pax Romana*, wars, illness, and invasions caused the Roman Empire to decline.

*Variation(s):* declined

**corrupt, adj.** having done something dishonest for personal gain (92)

*Example:* Weak emperors were often corrupt and did what was best for themselves instead of what was best for the empire.

*Variation(s):* corruption

**corruption, n.** the use of a government job for personal gain

**pillage, v.** to steal things using force (95)

*Example:* When Roman soldiers were not paid, they sometimes decided to pillage a town to take what they needed to survive.

*Variation(s):* pillaged

**collapse, v.** to fail or end suddenly (95)

*Example:* The Roman Empire grew so weak that it was about to collapse.

*Variation(s):* collapsed

## THE CORE LESSON 25 MIN

### Introduce “The Decline of the Roman Empire”

5 MIN

Remind students that the *Pax Romana* lasted for about two hundred years, a very long time. Explain that nothing lasts forever, though. Invite students to predict what happened after the *Pax Romana*. (*There must have been a war or crisis that ended the peace; otherwise, it would have lasted.*)

Tell students that in this chapter they will read again about Luciano as he learns about the many causes of the decline or weakening of Rome. Introduce the Big Question. Explain that Diocletian was a Roman emperor. Encourage students to look for reasons why Rome became weaker and ways that the decline was stopped or slowed.

### Guided Reading Supports for “The Decline of the Roman Empire” 20 MIN

When you or a student reads aloud, **always** prompt students to follow along. By following along, students may acquire a greater understanding of the content. Remember to provide discussion opportunities.

#### “Luciano’s Next Assignment,” Pages 90–91

Scaffold instruction as follows:

**CORE VOCABULARY**—Preview the term *assignment* in the second paragraph on page 90. After providing the definition for students, invite volunteers to use this term in a sentence about their own lives.

**CORE VOCABULARY**—Direct students’ attention to the term *decline* later in the same paragraph. After you read the definition, explain that this term also has a noun form. So Rome experienced a decline.

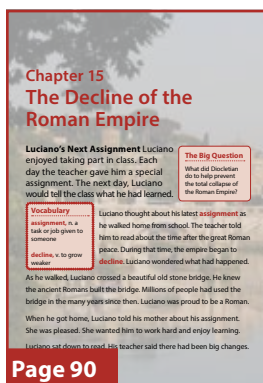



**Invite a volunteer to read the section. Then ask the following question:**

**INFERENTIAL**—Why is Luciano proud to be a Roman?

- » Luciano is walking across a bridge that the Romans originally built that is still used today. He is thinking about all of the Roman people who have used the bridge and their many accomplishments.

## “Weak and Corrupt Emperors,” Pages 92–93



**Read this section aloud to students, paragraph by paragraph. Scaffold instruction as follows:**

**CORE VOCABULARY**—Prior to reading aloud the third paragraph in this section, note the Core Vocabulary word *corrupt* and its definition. Ask students to think of other words that might describe a corrupt person (*examples include greedy, dishonest, criminal*).

**Continue reading the section aloud. Then ask the following questions:**

**LITERAL**—What are three things that contributed to the decline of the Roman Empire?

- » Possible answers: greedy, selfish emperors; provinces unprotected from barbarian attack; corrupt generals; civil wars that destroyed towns and farms and disrupted trade; disruption in trade leading to lack of food; people’s loss of homes and jobs; an atmosphere of fear throughout the empire.

**INFERENTIAL**—Why do you think bad leadership played such a big role in Rome’s decline?

- » Poor leadership meant that the government could not respond to problems in the empire.

## “The Barbarians Invade,” Pages 93–94

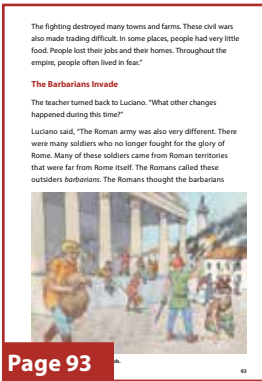

**Read the section aloud. Then ask the following question:**

**LITERAL**—Who were the barbarians, and what was the Roman attitude toward them?

- » The barbarians were people who lived outside the Roman Empire and in the most distant areas of the empire. The Romans considered them uncivilized and inferior.

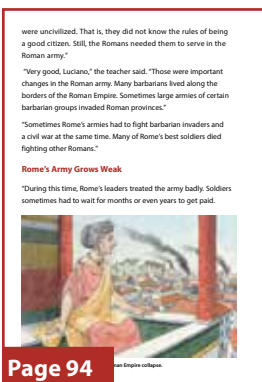



## “Rome’s Army Grows Weak,” Pages 94–95

Without money to buy food, the soldiers stole food to live. Many Roman soldiers lived by pillaging nearby farms and towns.

Over time, the Roman army became weak and dishonest, like the Roman government.

Meanwhile, the barbarian armies grew stronger. They forced the Romans out of large areas in the western and northern parts of the empire. Eventually, the Roman Empire was ready to collapse.

**Vocabulary**  
pillage, v. to steal things using force  
collapse, v. to fall or end suddenly

**Diocletian**

The teacher continued: “Then a strong, thoughtful man named Diocletian (/die\*oe\*klee\*shun/) became emperor. He defeated a fierce barbarian army. Luciano, can you tell us what else Diocletian did?”

Luciano jumped to his feet. He spoke in a clear voice.

“Diocletian changed the whole Roman government. He divided the empire into two parts with two emperors. One emperor governed the western part. Another governed the eastern part. Diocletian named honest, hardworking men to rule the empire with him. After he ruled for twenty years, he did what he had to do and gave up his job.”



This coin shows the emperor Diocletian wearing a laurel wreath. He ruled from 284 to 305 CE.

**Page 95**

Read the section aloud. Scaffold instruction as follows:

**CORE VOCABULARY**—At the end of the first paragraph, when you come to the word *pillaging*, stop and review the definition. Help students to think of other words that have a similar meaning (*stealing, robbing*).

**CORE VOCABULARY**—In the last paragraph, note the word *collapse*, and invite a volunteer to read the definition. To help students understand this term, discuss things that might collapse, such as a building.

Then ask the following questions:

**LITERAL**—In what way was the Roman army treated badly?

- » The soldiers were often not paid on time.

**LITERAL**—How did the mistreatment of the army hurt other people in Rome?

- » The soldiers turned to pillaging as a way of obtaining needed food and money.

**INFERENTIAL**—How did the weakening of the army help bring the empire to the brink of collapse?

- » The army was unable to counter the growing power of the barbarians.

## “Diocletian,” Page 95

Read the title of the section, clearly pronounce Diocletian’s name (/die\*oe\*klee\*shun/), and ask students to read quietly to themselves. Then ask the following question:

**LITERAL**—Who was Diocletian? What are two things that he did?

- » He became emperor after a long period of decline. He defeated a fierce barbarian army, divided the empire into east and west, ordered that there would be two emperors, and named honest, hardworking men to government posts. He also gave up his job voluntarily.



## CHECK FOR UNDERSTANDING 5 MIN

### Ask students to do one of the following:

- **Turn and Talk**—Ask a partner to answer the Big Question, “What did Diocletian do to help prevent the total collapse of the Roman Empire?”
  - » Key points students should cite include: he defeated a barbarian army, divided the empire into two parts with two emperors, and chose honest, hardworking men to rule the empire with him.
- Choose one of the Core Vocabulary words (*assignment*, *decline*, *corrupt*, *pillage*, or *collapse*), and say a sentence aloud using the word.

To wrap up the lesson, ask several students to share their responses.

## CHAPTER 16

# East and West

**The Big Question:** Why did the Western Empire collapse but the Eastern Empire survive for much longer?

### Primary Focus Objectives

- ✓ Identify Constantine as the first Christian emperor. (RI.3.2)
- ✓ Identify the areas of the Eastern and Western Empires on a map and name their capitals. (RI.3.2)
- ✓ Describe the fall of the Western Empire and the continuation of the Eastern Empire. (RI.3.2)
- ✓ Understand the meaning of the following domain-specific vocabulary: *practice* and *sack*. (RI.3.4)

### What Teachers Need to Know

For background information, download the CKHG Online Resource “About Constantine, the Eastern Empire, the Sack of Rome”:

[www.coreknowledge.org/ckhg-online-resources](http://www.coreknowledge.org/ckhg-online-resources)

### Core Vocabulary (Student Reader page numbers listed below)

**practice, v.** to live according to the teachings of a religion or other set of ideas (98)

*Example:* Emperor Constantine allowed Christians to practice their religion without fear of being persecuted.

*Variation(s):* practices, practiced, practicing

**sack, v.** to steal and destroy things in a city that has been defeated by an army (101)

*Example:* The barbarians decided to sack Rome.

*Variation(s):* sacks, sacked, sacking

## THE CORE LESSON 25 MIN

### Introduce “East and West”

5 MIN

Ask students if they remember what the emperor Diocletian did to the Roman Empire. (*He divided it into two parts.*) Ask students if they think this was a good idea or a bad idea. What dangers might be involved in separating the empire into two parts? What advantages might there be? (*The two parts could grow apart; on the other hand, if one were conquered, the other might survive.*)

Draw attention to the Big Question. Tell students that in this chapter, they will again read about Luciano as he learns about the very different fates of the two halves of the empire.

## Guided Reading Supports for “East and West”

20 MIN

When you or a student reads aloud, **always** prompt students to follow along. By following along, students may acquire a greater understanding of the content. Remember to provide discussion opportunities.

### “Luciano’s Last Assignment,” “Constantine Takes Control,” and “Constantinople,” Pages 96–99

Scaffold understanding as follows:

**CORE VOCABULARY**—Point out for students the term *practice* in the second paragraph on page 98, and discuss the definition, in the context of practicing a religion. Acknowledge that within the class, there are likely students who practice several different religions, such as Christianity, Judaism, Islam, Buddhism, Hinduism, or others. Ask students to provide an example of one way they practice their particular religions, such as going to a place of worship or saying prayers.

Direct students to read all three sections silently or in pairs. When students have finished reading, ask the following questions:

**EVALUATIVE**—Who was Constantine? How was he different from previous Roman emperors?

- » Constantine allowed Christians to practice their religion, which previous Roman emperors did not do. He is remembered as the first Christian emperor.

**LITERAL**—Looking at the map on page 99, where was the Eastern Empire, and what was its capital?

- » It covered the eastern part of the Roman Empire. Its capital was Constantinople, now known as Istanbul.

**Chapter 16**  
**East and West**

**Luciano’s Last Assignment** Luciano glanced ahead in his books. He knew the story of the Roman Empire was nearly over. He felt a little sad because this story was special to him.

**The Big Question**  
Why did the Western Empire collapse, but the Eastern Empire survive for much longer?

While studying the Roman Empire, Luciano discovered he liked taking part in class.

For his next assignment, the teacher told him to read about Emperor Constantine and the city of Constantinople. Luciano was curious. He hurried home to begin his studies.

**Constantine Takes Control**

The next day, the teacher told the class about Constantine. “After Diocletian retired, the Roman Empire fell into civil war. In time, a strong leader took control of the empire. His name was Constantine.”

**Page 96**



**Page 97** emperor holding a model of Constantinople

A key victory in Constantine’s rise to power came in 312 CE. At the Battle of the Milvian Bridge, Constantine defeated one of his rivals. Constantine was not yet a Christian. But he claimed the Christian God helped him win the battle.

In 313 CE, Constantine made an agreement with Licinius, who then ruled the eastern part of the empire. The two agreed to let Christians practice their religion.

This agreement was called the Edict of Milan. Christians were no longer punished for their beliefs. In fact, Constantine actively supported the Christian religion. He is remembered as the first Christian emperor.

“Constantine was a strong emperor. He followed Diocletian’s example. He named honest people to help him rule. After Constantine ruled the Roman Empire for a while, he moved the government away from Rome.”

The teacher turned to Luciano. “Luciano, where did Constantine move the government?”

**Constantinople**

Luciano was prepared. “In 324 CE, Constantine began moving the government of the Roman Empire to Byzantium. Byzantium was an old city in the eastern part of the empire. It had a big racetrack like Rome’s Circus Maximus.”

“Constantine thought that Byzantium should have a new name. He named it after himself.”

**Page 98**

## “The Byzantine Empire,” Pages 99–101

Read the section aloud. Then ask the following questions:

**LITERAL**—What was Byzantium, and what became of it?

- » Byzantium was another name for the Eastern Empire, and it continued for more than one thousand years after the fall of Rome and the Western Empire.

**CHALLENGE**—How was Constantinople similar to Rome? How was it different?

- » Like Rome, Constantinople was one of the most important cities in the world, and it attracted people from three different continents. Also, like Rome, it was governed by emperors. It was different because it was influenced by Middle Eastern styles of art and architecture.

**LITERAL**—Who was Justinian? What did he do?

- » Justinian was a Byzantine emperor. He built a Christian church called Hagia Sophia and created the Justinian Code by having all the different Roman laws written down in one place.

“You won’t find Constantinople on maps today,” Luciano continued. “The city’s name has changed. Today it’s called Istanbul, and it’s in the country of Turkey.”

“Thank you, Luciano,” said the teacher. “You did well.”

**The Byzantine Empire**

The teacher continued: “Constantine ruled from Constantinople for several years. After his death, there were more civil wars. The western part of the Roman Empire eventually broke away from the eastern part. There were now two empires instead of one.”



Eastern and Western Roman Empires, 330 CE

99

Page 99

“The Eastern Empire included Constantinople. Because the city was once called Byzantium, the empire was called the Byzantine Empire. The Byzantine Empire became powerful and lasted for more than one thousand years.”

“Constantinople became one of the most important cities in the world. It attracted traders and travelers from Asia, Africa, and Europe. Byzantine philosophers talked about important ideas. Artists blended Greek, Roman, and Middle Eastern styles to create beautiful mosaics and other works of art.”

“The Eastern Empire was ruled by a series of emperors. Justinian was one of its most famous emperors. In Constantinople, Justinian built a beautiful Christian church called Hagia Sophia (hahy’jah soh’fee’uh).”



100

Page 100

## “The Western Empire,” Page 101

Scaffold understanding as follows:

**CORE VOCABULARY**—In the second paragraph of this section, note the term *sacked*. Read the definition of this term. Invite students to think of synonyms for this word that describe what happened to Rome. (Possible responses: *ransacked, trashed, looted, destroyed*.)

Now read the entire section aloud. Then ask the following questions:

 **LITERAL**—Where was the Western Empire, and what was its capital?

- » It covered the western part of the Roman Empire. Its capital was Rome.

**LITERAL**—How was the Western Empire different from the Eastern Empire?

- » It was less wealthy, surrounded by warlike neighbors, and subject to frequent barbarian attacks.

**LITERAL**—How and when did the Western Empire end?

- » The Western Empire ended in 476 CE when a barbarian leader forced the emperor of the Western Empire to surrender and give up his throne.

“Although Justinian ruled the Eastern Empire, far from Rome, he knew the Romans had built his empire. The empire was governed by Roman laws. Justinian had these Roman laws written down. This collection of laws was known as the Justinian Code.”

**The Western Empire**

The teacher continued: “The Western Empire was not as strong as the Eastern Empire. By the time Justinian became emperor in the East, the Western Empire had collapsed.”

“How did this happen? The Western Empire was less wealthy than the Eastern Empire. It was also surrounded by warlike neighbors. Barbarians often attacked the borders of the Western Empire. Over time, these barbarians took over more and more Roman land. The armies of the Western Empire could not stop them. Eventually the barbarians **sacked** the city of Rome.”

**Vocabulary**

**sack**, to steal and destroy things in a city that has been defeated by an army

“The Western Empire kept fighting the barbarians for another sixty years. Finally, in 476 CE, the emperor of the Western Empire surrendered to a barbarian leader. The Western Empire had fallen. This event is called the fall of Rome.”

“We have reached the end of our exploration of ancient Rome,” said the teacher. “We should thank Luciano for helping us to know and understand the Romans. Thank you, Luciano. We are proud of you.”

101

Page 101

## Timeline

- Show students the Chapter 16 Timeline Image Cards. Read and discuss the captions, making particular note of any dates.
- Review and discuss the Big Question, “Why did the Western Empire collapse but the Eastern Empire survive for much longer?”
- Post the image cards as the eleventh, twelfth, and thirteenth images on the Timeline, under the dates referencing the 300–399 CE and 400–499 CE, as appropriate; refer to the illustration in the Unit 2 Introduction for further guidance on the placement of each image card to the Timeline.



### CHECK FOR UNDERSTANDING 5 MIN

#### Ask students to do one of the following:

- **Turn and Talk**—Ask a partner to answer the Big Question, “Why did the Western Empire collapse but the Eastern Empire survive for much longer?”
  - » Key points students should cite include: the Western Empire was less wealthy than the Eastern Empire and was subject to frequent barbarian attacks.
- Choose one of the Core Vocabulary words (*practice* or *sack*), and say a sentence aloud using the word.

To wrap up the lesson, ask several students to share their responses.

## Additional Activities

### Domain Vocabulary: Chapters 15–16 (L.3.6)

30 MIN

Activity Page



AP 16.1

Distribute the Domain Vocabulary: Chapters 15–16 (AP 16.1) found in the Teacher Resources section (page 164). Direct students to answer the riddles by using words from the Word Bank, based on what they have learned about ancient Rome.



### Virtual Field Trip: Hagia Sophia (SL.3.2)

30 MIN

**Materials Needed:** Access to online images of the Hagia Sophia.

**Alternate Art Activity for Hagia Sophia: If you do not have classroom access to the internet, you can purchase the Core Knowledge Curriculum Series™ Art Resource packet for Grade 3, available at:**

[www.coreknowledge.org/store](http://www.coreknowledge.org/store)

**Use this art resource to guide students through the following activity.**

**Background for the Teacher:** Familiarize yourself with the history of Hagia Sophia by using this link to download the CKHG Online Resources for this unit, where the specific links for Hagia Sophia may be found:

[www.coreknowledge.org/ckhg-online-resources](http://www.coreknowledge.org/ckhg-online-resources)

- Wonders of the World Databank: Hagia Sophia
- Heilbrunn Timeline of Art History: Hagia Sophia, 532–37

### **Introduce Hagia Sophia**

Remind students that Hagia Sophia was built by the Byzantine Emperor Justinian as a Christian church in 537 *CE*. It took a crew of ten thousand workers almost six years to build the church. After the fall of the Byzantine Empire, Hagia Sophia was used as a mosque. Today it is a museum.

### **Visit Hagia Sophia**

Using the primary unit link to the Core Knowledge web page, you can find specific links for the following virtual tour of Hagia Sophia. Images may be downloaded and used in a slide-show presentation.

Begin the virtual tour by displaying the art resource of Hagia Sophia or online images of the exterior of Hagia Sophia found by clicking on the following:

- Hagia Sophia | World Religions: Christianity
- Hagia Sophia, 6<sup>th</sup>–16<sup>th</sup> century, Istanbul (UNESCO World Heritage List) | Wonders of the World

Explain that the building is made largely out of concrete. Point out elements of Roman architecture used in the church, such as the dome and the arches. If students took the Virtual Field Trip to the Pantheon, point out that the dome of Hagia Sophia is about forty feet smaller in diameter than the dome of the Pantheon. Note that the spires are minarets and that they were added in the 1500s when the church was converted into a mosque.

Next, display images these images from the Online Resources:

- Hagia Sophia, Sultanahmet, Istanbul, Turkey | Wonders of the World
- Magnificent interiors of Hagia Sophia, Istanbul | Wonders of the World
- Hagia Sophia | Wonders of the World
- Turkey, Istanbul, Hagia Sophia, Interior of mosque | Wonders of the World

Have students note how the dome and arches create a bright open space inside the building. Explain that the Arabic writing is a reflection of the building's use as a mosque and its location in a Muslim country. Explain that the interior was redecorated with Islamic art when the church was converted to a mosque in the 1500s.

Display images of Christian mosaics that decorate the interior of the building by clicking on the following:

- Turkey, Istanbul, Hagia Sophia Mosque, Mosaic of Christ Pantocrator with John the Baptist | World Religions: Christianity
- Emperor Constantine IX, Hagia Sofia, Istanbul | World Religions: Christianity

When the church was converted to a mosque, the Christian mosaics were covered over. When the building was converted to a museum, however, the original mosaics were restored.

As you review these images, use the following “looking questions” to focus students’ attention:

- Here’s a famous building in Istanbul, Turkey, called Hagia Sophia. What architectural forms and shapes do you see?
  - » Students should point out the large dome and smaller dome, as well as the tall, thin towers on the right (called *minarets*).
- Have we seen any other buildings that have domes?
  - » Students may mention the Pantheon or other domed buildings they know.
- What kind of building do you think this might be?
  - » Originally it was a church. Then Istanbul was taken over by Muslims, and the church was made into a Muslim mosque. The minarets were added when the building was turned into a mosque.
- What might it feel like to stand inside, under the great dome of Hagia Sophia?
  - » Answers will vary. The great dome towers high above your head and glitters with gold and mosaics. You may wish to show students the art print of the mosaic, as well as an interior view of Hagia Sophia’s dome (not provided but widely available online at websites such as those provided in the above links).



### Byzantine Mosaics (SL.3.3, W.3.1)

30 MIN

**Alternate Art Activity for a Byzantine Mosaic: If you do not have classroom access to the Internet, you can purchase the Core Knowledge Curriculum Series™ Art Resource packet for Grade 3, available at:**

[www.coreknowledge.org/store](http://www.coreknowledge.org/store)

**Use this art resource to guide students through the following activity.**



**Background for the Teacher:** Familiarize yourself with Byzantine mosaics by using this link to download the CKHG Online Resources for this unit, where the specific link for Byzantine Mosaics may be found.

[www.coreknowledge.org/ckhg-online-resources](http://www.coreknowledge.org/ckhg-online-resources)

### Analyze a Byzantine Mosaic

Choose one of the mosaics found in the Online Resource, Byzantine Mosaic.

- Byzantine: Mosaic

If you choose to use the mosaic “Christ Between the Virgin and Saint John the Baptist,” use the following “looking questions” to focus students’ attention:

- Who is this? How can you tell?
  - » It is Jesus. Some signs are the halo, the Greek cross behind his head, the book that appears with him (possibly the Bible), and the characteristic hand gesture, which is the gesture of the blessing. The larger mosaic (not pictured here) also shows Jesus’s mother, Mary, and John the Baptist.
- Can you tell how the picture was made?
  - » It’s a mosaic, made up of tiny pieces of colored glass.
- Mosaics are put up on walls, usually in buildings. In what kind of building would you expect to find this?
  - » Answers will vary. Students may suggest a church. Tell them that this mosaic is one of many mosaics on the walls of Hagia Sophia, an old and famous church in Istanbul, Turkey.
- What impression does this image make when light floods into the building?
  - » The glass catches the light and causes a shimmering “heavenly” effect.

### Write a Response

Have students write a brief response to the mosaic: What did they think of it? Did they like it? What did they find most impressive or noticeable? Would they like to own or create a mosaic themselves?

If time allows, invite volunteers to share their responses.



### Making a Mosaic

30 MIN

**Materials Needed:** (1) Small squares of colored paper (copy, construction, or tissue) in a variety of colors, (2) full sheets of solid-colored paper, glue or glue sticks.

Review with students how artists used small, individual pieces of color to create facial features in mosaics. Then have students create an image of their own face by gluing small squares of colored paper onto a sheet of solid-colored paper.

Remind students that the purpose of the experience is to gain an appreciation for what it was like to create mosaics, not to create exact replicas of themselves.

### *The Justinian Code*

30 MIN

**Materials Needed:** Sufficient copies of *The Justinian Code* (NFE 2), found in the CKHG Online Resources for this unit:

[www.coreknowledge.org/ckhg-online-resources](http://www.coreknowledge.org/ckhg-online-resources)

This is an abridged version of the Justinian Code, a written record of Roman laws commissioned by Justinian when he was emperor of the Eastern Empire. The language of this document may prove too difficult for many third graders.

We include it here in the event that you choose to use it as a CHALLENGE activity. You may also decide to read the document aloud in a very scaffolded way as students follow along.

Possible questions include the following:

**LITERAL**—According to the Justinian Code, what are the maxims—or basic truths—of law?

- » The basic maxims are to live honestly, to hurt no one, and to give everyone his or her due (which means, “what a person deserves”).

**LITERAL**—What is the difference between public and private law?

- » Public law has to do with the government of the Roman Empire, and private law relates to the interests or rights of individuals.

**EVALUATIVE**—According to the Justinian Code, what represents a public resource?

- » Things that are used by all people and owned by no one individually are public.

Students who have used a curriculum based on the *Core Knowledge Sequence* studied the Code of Hammurabi in Grade 1 while learning about the ancient civilization of Mesopotamia.

# Teacher Resources

<b>Unit Assessment: <i>Ancient Rome</i></b>	<b>127</b>
<b>Performance Task: <i>Ancient Rome</i></b>	<b>132</b>
• <b>Performance Task Scoring Rubric</b>	<b>134</b>
• <b>Performance Task Activity: <i>Ancient Rome</i></b>	<b>135</b>
• <b><i>Ancient Rome</i> Performance Task Notes Table</b>	<b>136</b>
<b>Activity Pages</b>	
• World Map (AP 1.1)	<b>137</b>
• World Geography (AP 1.2)	<b>138</b>
• Map of the Mediterranean Region (AP 1.3)	<b>139</b>
• Geography of the Mediterranean Region (AP 1.4)	<b>140</b>
• The Legend of Romulus and Remus (AP 1.5)	<b>141</b>
• The Solar System (AP 2.1)	<b>142</b>
• The Roman Republic (AP 3.1)	<b>144</b>
• Life in Rome (AP 3.2)	<b>145</b>
• Domain Vocabulary: Chapters 1–4 (AP 4.1)	<b>147</b>
• Cleopatra’s Egypt (AP 6.1)	<b>148</b>
• Antony and Octavian (AP 7.1)	<b>150</b>
• Domain Vocabulary: Chapters 5–7 (AP 7.2)	<b>151</b>
• Comparing Sources About Augustus (AP 8.1)	<b>153</b>
• Geography of the Roman Empire (AP 9.1)	<b>154</b>
• Then and Now (AP 9.2)	<b>156</b>
• Roads and Bridges (AP 10.1)	<b>157</b>
• The Pantheon (AP 11.1)	<b>159</b>
• Domain Vocabulary: Chapters 8–11 (AP 11.2)	<b>160</b>

- Androcles and the Lion (AP 12.1) **161**
- Domain Vocabulary: Chapters 12–14 (AP 14.1) **162**
- Domain Vocabulary: Chapters 15–16 (AP 16.1) **164**

**Answer Key: *Ancient Rome*** **165**

**The following nonfiction and fiction excerpts (Primary Source Documents) can be found and downloaded at:**

**[www.coreknowledge.org/ckhg-online-resources](http://www.coreknowledge.org/ckhg-online-resources)**

### **Fiction Excerpts**

- “Androcles and the Lion” (FE 1)

### **Nonfiction Excerpts**

- Primary Source Document: From Pliny the Younger’s *Letters to Tacitus* (NFE 1)
- Primary Source Document: The Justinian Code (Abridged) (NFE 2)

Name \_\_\_\_\_

Date \_\_\_\_\_

## **Unit Assessment: Ancient Rome**

---

**Circle the letter of the best answer.**

1. Who were Romulus and Remus?
  - a) the two faces of one god
  - b) the two biggest hills in Rome
  - c) the first and last emperors of Rome
  - d) the twin brothers who, according to legend, founded Rome
  
2. The ancient Romans believed in
  - a) one God.
  - b) no one but Caesar.
  - c) many gods and goddesses.
  - d) the goodwill of the natural world.
  
3. In the Roman Republic, who were the patricians?
  - a) dictators who had total control over the country
  - b) members of powerful and wealthy families
  - c) poor working men and women
  - d) legions of Roman soldiers
  
4. In the Roman Republic, who were the plebeians?
  - a) dictators who had total control over the country
  - b) members of powerful and wealthy families
  - c) poor working men and women
  - d) legions of Roman soldiers
  
5. In the Punic Wars, Rome fought against
  - a) Carthage.
  - b) Constantinople.
  - c) Egypt.
  - d) Greece.
  
6. Who conquered Gaul and became a dictator during the last days of the Roman Republic?
  - a) Hannibal
  - b) Pompey
  - c) Julius Caesar
  - d) Marc Antony

7. Who assassinated Julius Caesar?
  - a) Marc Antony
  - b) Roman senators, including Caesar's friend Brutus
  - c) Cleopatra
  - d) Caesar Augustus
  
8. The queen of Egypt who helped Marc Antony was
  - a) Cleopatra.
  - b) Nefertiti.
  - c) Octavia.
  - d) Vesta.
  
9. Who became known as Caesar Augustus, Rome's first emperor, after he took power?
  - a) Marc Antony
  - b) Octavian
  - c) Brutus
  - d) Pompey
  
10. The Roman Empire spread over nearly all the lands surrounding the
  - a) Black Sea.
  - b) North Sea.
  - c) Mediterranean Sea.
  - d) Red Sea.
  
11. Rome's provinces were connected to one another and the capital by
  - a) aqueducts.
  - b) well-built roads.
  - c) long-distance runners.
  - d) an early form of the telegraph.
  
12. What symbol of Rome was built on a hill in Rome to honor the king of the gods?
  - a) the Temple of Jupiter
  - b) the marketplace
  - c) the Colosseum
  - d) the Forum
  
13. What did Romans watch at the Colosseum?
  - a) chariot races
  - b) debates between senators
  - c) comedies and tragedies being performed
  - d) fights between gladiators and wild beasts

- 14.** What did Romans watch at the Circus Maximus?
- a) chariot races
  - b) debates between senators
  - c) comedies and tragedies being performed
  - d) fights between gladiators and wild beasts
- 15.** How was Pompeii destroyed?
- a) It was covered by a huge flood.
  - b) It was conquered by Julius Caesar.
  - c) It was buried by a volcanic eruption.
  - d) It was devastated by a Greek invasion.
- 16.** Why is Pompeii important to archaeologists?
- a) It was the capital of the Roman Empire.
  - b) It inspired the Romans to create a fire department.
  - c) Its buildings and objects were well preserved for centuries.
  - d) It was the first part of Rome to fall to invading armies from Europe.
- 17.** What was the *Pax Romana*?
- a) a disease that killed most of the people of Rome
  - b) the name the Romans gave the Latin language
  - c) a peace treaty between Rome and Athens
  - d) two hundred years of peace in the Roman Empire
- 18.** During the *Pax Romana*, Rome grew
- a) weaker and poorer.
  - b) wealthier and larger.
  - c) more fair and democratic.
  - d) more unified but less wealthy.
- 19.** Why did the Romans persecute the Christians?
- a) The Christians threatened to attack the empire.
  - b) The Christians were from foreign lands.
  - c) The Christians had different religious beliefs.
  - d) The Christians blamed Nero for burning Rome.
- 20.** How did the Roman army change as the empire declined?
- a) It grew stronger and became more civilized.
  - b) It tried to kill the family and friends of old emperors.
  - c) It grew weaker, and many soldiers stole food to survive.
  - d) It beat the barbarian armies on the borders of the empire.

- 21.** Who was Constantine?
- a)** the first Roman emperor to accept Christianity
  - b)** the emperor who brought democracy to Rome
  - c)** the first emperor who tried to wipe out the Christians
  - d)** the emperor who was on the throne when Rome finally fell
- 22.** The Western Roman Empire ended in
- a)** 100 *BCE*.
  - b)** 476 *CE*.
  - c)** 1066 *CE*.
  - d)** 1492 *CE*.



**Match each term to its definition.**

**Terms**

23. \_\_\_\_\_ empire

24. \_\_\_\_\_ citizen

25. \_\_\_\_\_ republic

26. \_\_\_\_\_ tax

27. \_\_\_\_\_ foreigner

28. \_\_\_\_\_ aqueduct

29. \_\_\_\_\_ strait

30. \_\_\_\_\_ arena

31. \_\_\_\_\_ mosaic

32. \_\_\_\_\_ collapse

**Definitions**

a) money that people pay to the government

b) someone from another country

c) a structure for carrying water across long distances

d) to fail or end suddenly

e) an area surrounded by seating for the public where sports events are held

f) a government in which people elect others to represent them

g) a narrow body of water that connects two large bodies of water

h) a group of countries or territories under the control of one ruler

i) a person who belongs to a country and has protections under that country's laws

j) artwork made of many small pieces of colorful stone or tile

## Performance Task: *Ancient Rome*

There are many reasons for the growth and decline of the power of Rome. Historians may argue about which reasons are most telling, but the basic facts are clear: Rome grew into an empire whose power faded away.

Ask students to write a brief essay that explains why Rome developed into a powerful empire and why it collapsed. Encourage students to use their Student Reader to take notes and organize their thoughts in the table provided.

A sample table, completed with possible notes, is provided below to serve as a reference for teachers, should some prompting or scaffolding be needed to help students get started. Individual students are not expected to provide a comparable finished table. Students should identify a single effect for each cause given.

<b>Strengths</b>	
<b>Causes</b>	<b>Effects</b>
<b>1.</b> Rome's original location made it hard for enemies to attack.	<b>1.</b> Rome was able to grow in safety.
<b>2.</b> Roman government was a republic.	<b>2.</b> Rome had a stable, well-functioning government.
<b>3.</b> People in Rome shared religious beliefs.	<b>3.</b> Rome had a strong, stable society with shared beliefs and values.
<b>4.</b> All parts of Rome were connected by roads.	<b>4.</b> Rome could easily move troops to all area to maintain peace and security.
<b>5.</b> Roman society had a clear structure (patricians, plebeians, representative government).	<b>5.</b> Rome was a strong, stable society.
<b>6.</b> The Roman army and navy grew powerful and committed, and it conquered lands around the Mediterranean.	<b>6.</b> Rome was able to defeat all threats and expand its power and control.
<b>7.</b> Rome won the Punic Wars.	<b>7.</b> Rome defeated a powerful rival.
<b>8.</b> Rome copied ideas and buildings from ancient Greece.	<b>8.</b> Rome built a glorious culture.
<b>9.</b> Rome had strong leaders like Julius Caesar and Caesar Augustus.	<b>9.</b> Strong leadership helped Rome thrive in times of war and peace.

## Weaknesses

Causes	Effects
1. Corrupt leaders failed to solve problems and ignored people's needs.	1. Unrest among the Roman population grew.
2. Emperors chose greedy army generals who then took over as emperor.	2. Some leaders put their own interests ahead of Rome's.
3. Civil wars sometimes occurred.	3. Internal fighting weakened the empire.
4. Powerful patricians were killed.	4. Rome lost important leaders.
5. Foreigners joined the army and Rome's leaders mistreated the army.	5. The once-mighty Roman army grew weaker.
6. The empire was split in two.	6. The Eastern Roman Empire held much of the power.
7. Barbarians sacked the Western Roman Empire.	7. The attacks weakened the Western Roman Empire, which finally collapsed.

## Performance Task Scoring Rubric

---

**Note:** Students should be evaluated on the basis of their written essays, using the rubric.

Students should not be evaluated on the completion of the evidence table, which is intended to be a support for students as they first think about their written responses.

<b>Above Average</b>	Response is accurate and detailed. The writing includes at least three factual causes for both Rome's growth and its decline. The writing uses linking words and phrases to connect ideas, demonstrating strong understanding of the subject discussed. A few minor errors may be present.
<b>Average</b>	Response is mostly accurate and somewhat detailed. The writing includes at least two factual causes for both Rome's growth and its decline. The writing uses some linking words or phrases to connect ideas. Some minor errors may be present.
<b>Adequate</b>	Response is mostly accurate but lacks detail. The essay gives facts about Rome but does not connect them to causes or effects. The writing may exhibit issues with organization, focus, and/or control of standard English grammar.
<b>Inadequate</b>	Response is incomplete and demonstrates a minimal understanding of the content in the unit. The writing may exhibit major issues with organization, focus, and/or control of standard English grammar.

Name \_\_\_\_\_

Date \_\_\_\_\_

## **Performance Task Activity: *Ancient Rome***

---

Why did Rome develop into a powerful empire? Why did it collapse? Give three causes and three effects of what happened to Rome.

Use the table on the next page to take notes and organize your thoughts. You may look back at the chapters in *Ancient Rome*.

---

---

---

---

---

---

---

---

---

---

---

---

---

---

---

---

---

---

---

---

---

---

---

---

---

---

---

### **Ancient Rome Performance Task Notes Table**

Use the table below to help organize your thoughts about Rome. You do not need to complete the entire table to write your essay, but you should have one cause for each effect. A few examples have been provided for you.

<b>Strengths</b>	
<b>Causes</b>	<b>Effects</b>
1. Rome’s original location made it hard for enemies to attack.	1. Rome was able to grow in safety.
2. Roman government was a republic.	2. Rome had a stable, well-functioning government.
3.	3.
4.	4.
5.	5.
6.	6.
7.	7.
8.	8.
9.	9.
<b>Weaknesses</b>	
<b>Causes</b>	<b>Effects</b>
1.	1. Unrest among the Roman population grew.
2.	2.
3.	3.
4.	4.
5.	5.
6.	6.
7.	7.

Name \_\_\_\_\_ Date \_\_\_\_\_

World Map

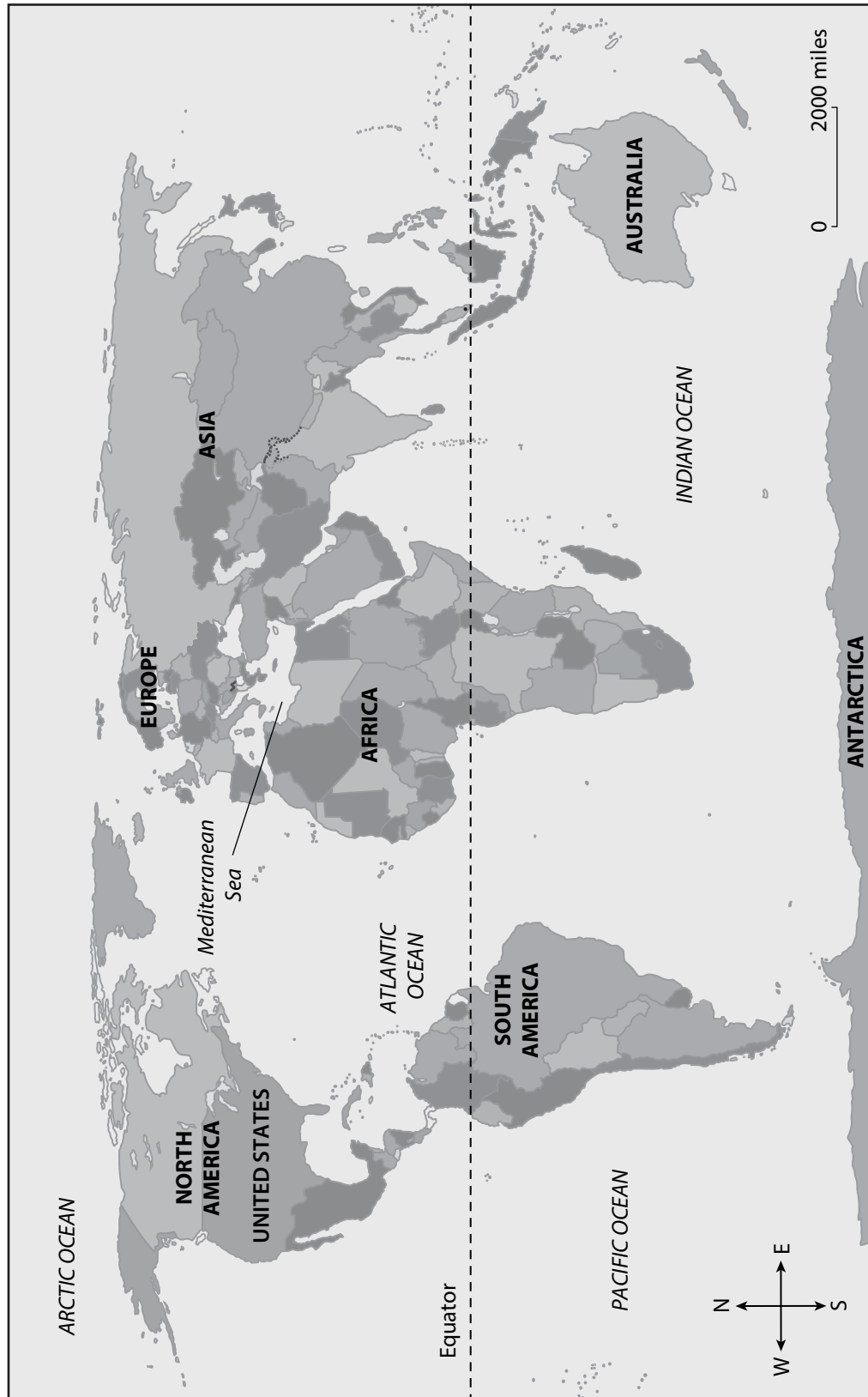

Name \_\_\_\_\_

Date \_\_\_\_\_

**Activity Page 1.2: World Geography**

**Use with Chapter 1**

1. Which continents does the equator pass through?

\_\_\_\_\_

2. What body of water separates the Americas from Europe and Africa?

\_\_\_\_\_

3. Are the Americas farther from Europe or from Asia?

\_\_\_\_\_

4. Which bodies of water border Europe?

\_\_\_\_\_

5. Which body of water separates Europe and Africa?

\_\_\_\_\_



Name \_\_\_\_\_

Date \_\_\_\_\_

Map of the Mediterranean Region

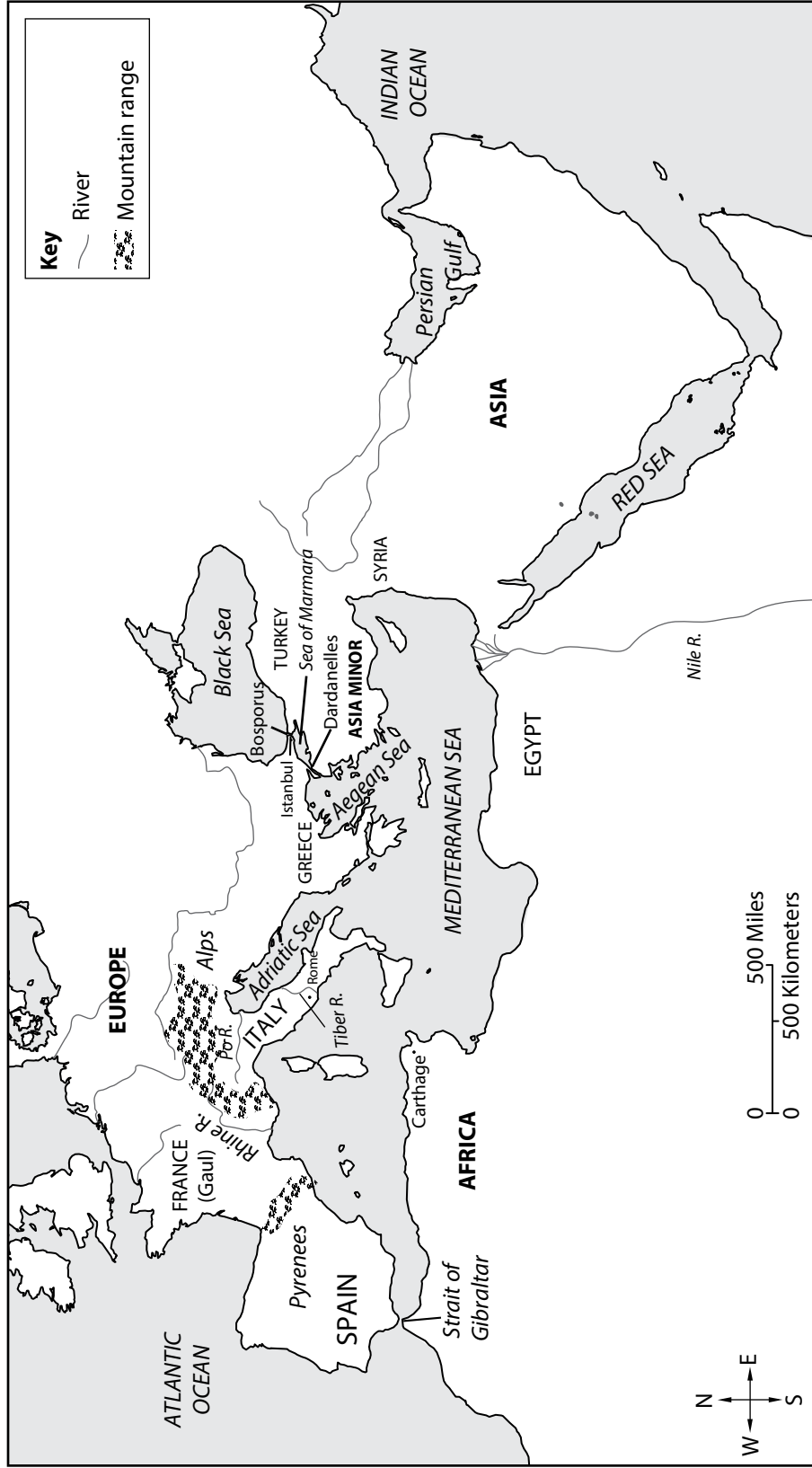

Name \_\_\_\_\_

Date \_\_\_\_\_

**Activity Page 1.4: Geography of the Mediterranean Region**

**Use with Chapter 1**

1. Which continents border the Mediterranean Sea?

\_\_\_\_\_

2. Which two natural passageways link the Mediterranean Sea and the Black Sea to the east and the Atlantic Ocean to the west?

\_\_\_\_\_

3. Which European country is on a peninsula that is shaped like a boot?

\_\_\_\_\_

4. What mountains separate France and Italy?

\_\_\_\_\_

5. If you traveled from Europe to Africa across the Mediterranean Sea, in what direction would you be traveling?

\_\_\_\_\_

6. Using the map scale, estimate the distance between Rome and Carthage.

\_\_\_\_\_

Name \_\_\_\_\_

Date \_\_\_\_\_

**Activity Page 1.5: The Legend of Romulus and Remus**

**Use with Chapter 1**

Title: \_\_\_\_\_

Subtitle \_\_\_\_\_

Name \_\_\_\_\_  
Date \_\_\_\_\_

**The Solar System**

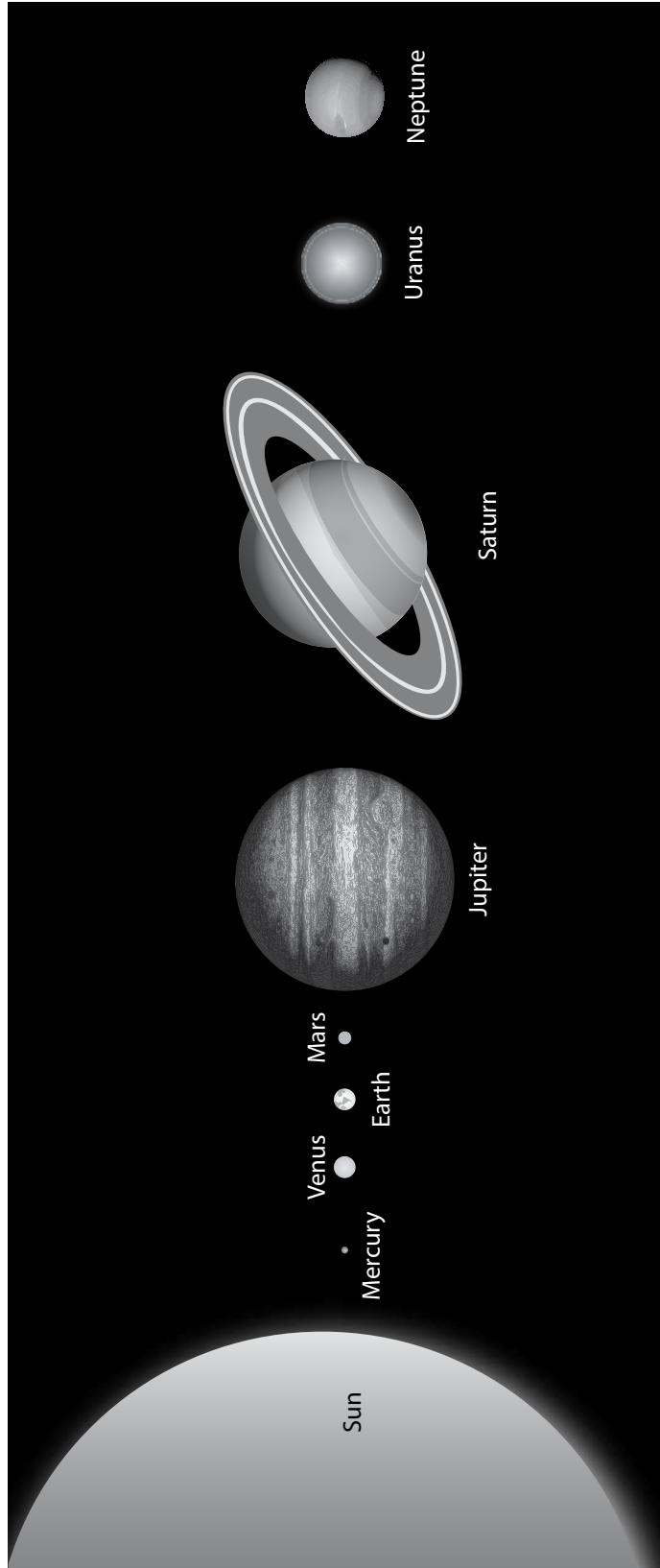

Name \_\_\_\_\_

Date \_\_\_\_\_

**Activity Page 2.1: *Continued***

**Use with Chapter 2**

**Most of the planets in our solar system are named for Roman gods or goddesses. Fill in the chart with information the teacher gives you.**

<b>Planet</b>	<b>Roman God or Goddess It Is Named For</b>	<b>Reason for the Name</b>
Mercury		
Venus		
Mars		
Jupiter		
Saturn		
Neptune		

**Activity Page 3.1: The Roman Republic**

**Use with Chapter 3**

**Complete the diagram with information about the government of the Roman Republic. Use words from the word choice box to complete each sentence. Place the letter that appears next to each word in the proper blank in the diagram.**

- |             |               |              |             |
|-------------|---------------|--------------|-------------|
| A. dictator | B. plebian    | C. patrician | D. assembly |
| E. consul   | F. controlled |              |             |

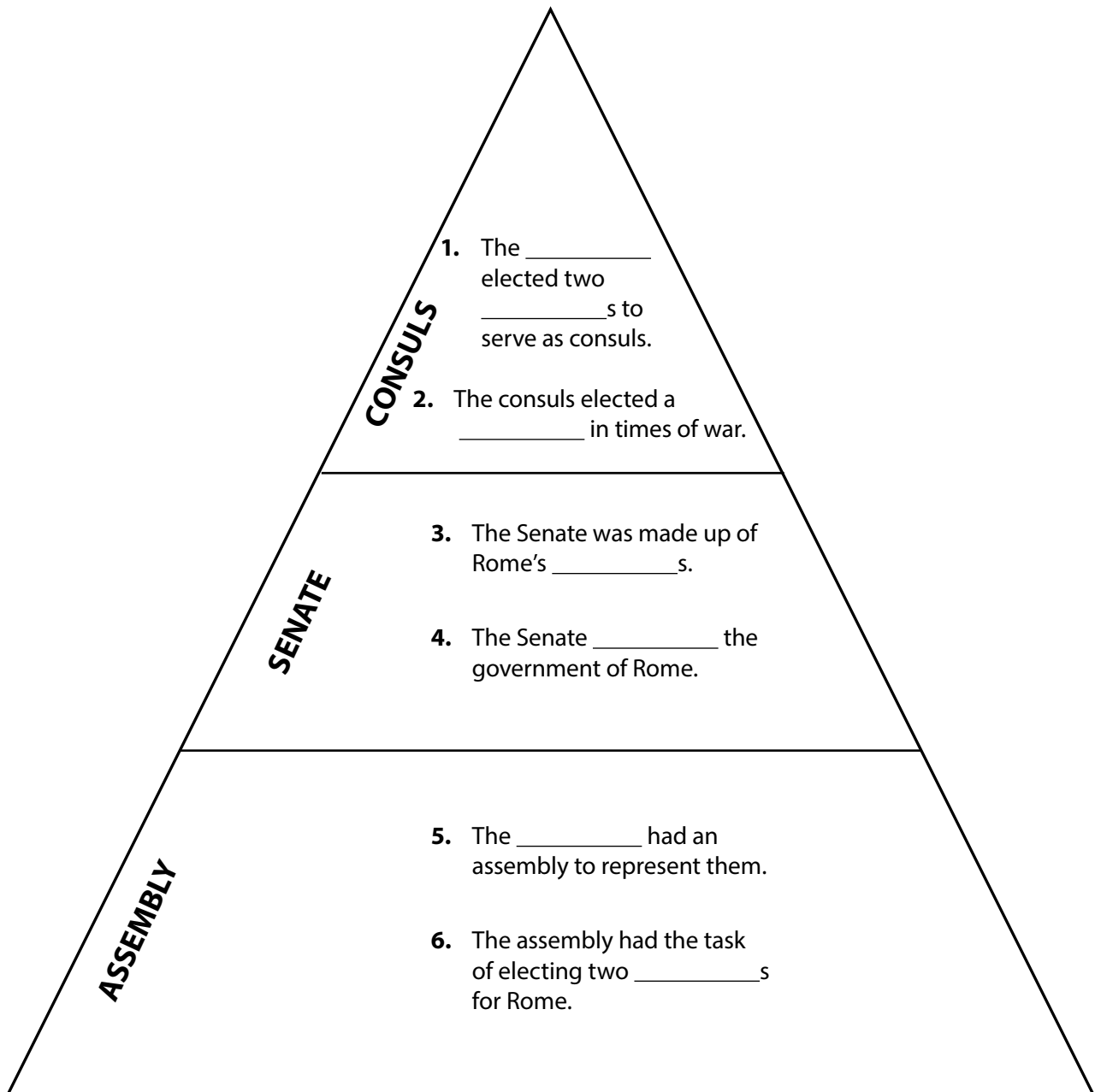

Name \_\_\_\_\_

Date \_\_\_\_\_

### Activity Page 3.2: Life in Rome

### Use with Chapter 3

Rome was one of the largest cities of its time. What was it like to live in this ancient city?

For one, the city was very crowded and busy. At the center of Rome was a street called the *Via Sacra*. The *Via Sacra* led to the Forum, the center of Roman life. During the republic, the northern corner of the Forum was used for government business. The rest of the Forum was used for shops and markets. The Forum was busiest in the middle of the day. Businesspeople made deals. Courts held trials. Government officials met and debated.

Most Romans were plebeians. Many plebeians lived together in different rooms or apartments in buildings in an area east of the Forum. These buildings did not have plumbing or running water. They were hot in summer and cold in winter. They filled with smoke from cooking fires. The plebeian parts of the city were known for their narrow streets. These narrow passages made it easier for fire to spread. They also made it easier for thieves to steal from passersby.

The patricians of Rome were a small part of the population, but they had a lot of living space. They lived in large, private homes. These homes had several rooms arranged around a courtyard.

For clothing, Roman men of all ranks wore a tunic. This is a kind of long shirt without sleeves. A man's tunic went down to about the knees and was worn with a belt. Over the tunic, male citizens often wore togas. Different colors, stripes, and decorations on clothing helped show a man's rank or position.

Most women did not wear togas. They wore longer tunics, sometimes with sleeves. Women's clothing varied less than men's. So women of high rank used jewelry and hairstyles to set them apart from other women.

In the early days of the republic, Rome did not have public education. Each family was responsible for teaching its own children. Patrician families hired tutors to teach their children. Plebeian children learned from their parents. Often, they only learned to do the job their parents did.

Roman women could not participate in government, but they were allowed to go out and about in the city. They visited temples, shopped in the Forum, attended games, and met with their friends in public. Their main job, though, was to raise their children.

One thing that all Romans shared in common was language. Patricians and plebeians all spoke Latin, the language of Rome.

Another thing common to all Romans was religion. Romans worshipped many different gods, and each household had its favorite. The Roman government also dedicated the Roman state to the worship of many gods. Jupiter, for example, was the protector of all of Rome. As Rome grew and expanded, new gods and practices were sometimes added from conquered lands.

[LEXILE: 720L]

Name \_\_\_\_\_ Date \_\_\_\_\_

Fill in the diagram with details about patricians and plebeians. Facts that are true about both groups should go in the middle of the diagram.

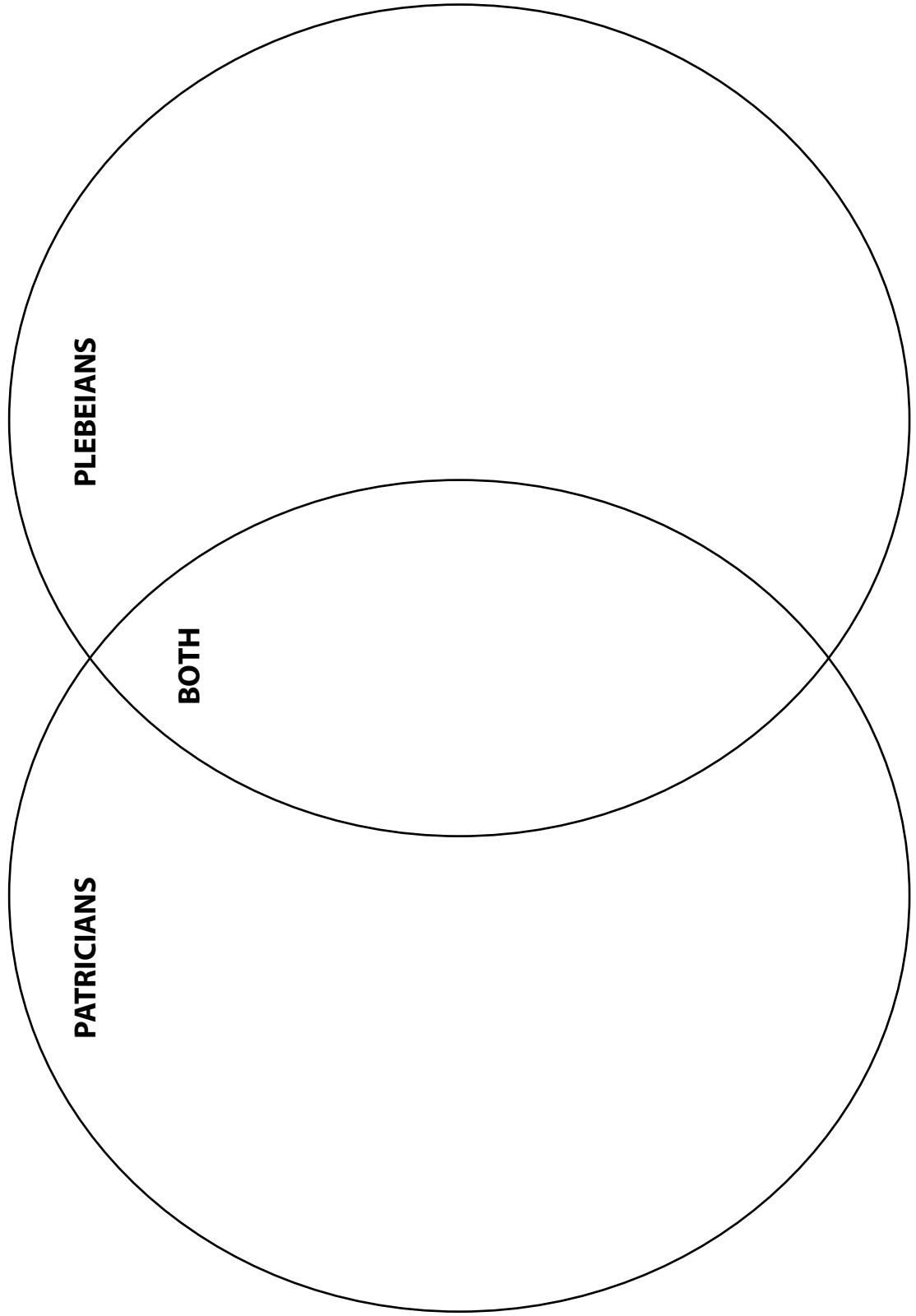



Name \_\_\_\_\_

Date \_\_\_\_\_

### Activity Page 4.1 Domain Vocabulary: Chapters 1–4

### Use with Chapter 4

**Note:** This activity refers to content found in Chapters 1–4.

#### Circle the best word to fill each blank.

1. Rome began as a small city on a hill. But in time, it became the (capital, barrier, dictator) of the country of Italy.
2. At first Rome was governed by (gods, kings, senators). In 509 BCE, Rome became a(n) (assembly, empire, republic) with elected (citizens, dictators, representatives).
3. Although most people in the Roman Republic were (patricians, plebeians, senators), the government was controlled by the (assembly, king, Senate), whose members were all (consuls, patricians, plebeians).
4. Romans believed the (god, goddess, legend) Vesta watched over the city's fire. To honor Vesta, they built a (barrier, chariot, temple) in the Roman (assembly, Forum, Senate).
5. The Romans believed that the smell of (charcoal, symbols, peninsulas) meant their homes were protected by Vesta. Therefore, they kept a (plebeian, representative, sacred) fire burning at all times.
6. If an enemy threatened Rome, the two (consuls, patricians, senators) could choose a (dictator, king, legion) to rule the city for up to six months.
7. During the Punic Wars, the Romans thought the (barrier, formation, embers) of the Alps would protect them against invasion by Hannibal's army.

Name \_\_\_\_\_

Date \_\_\_\_\_

### Activity Page 6.1 Cleopatra's Egypt

Use with Chapter 6

Map of Cleopatra's Egypt

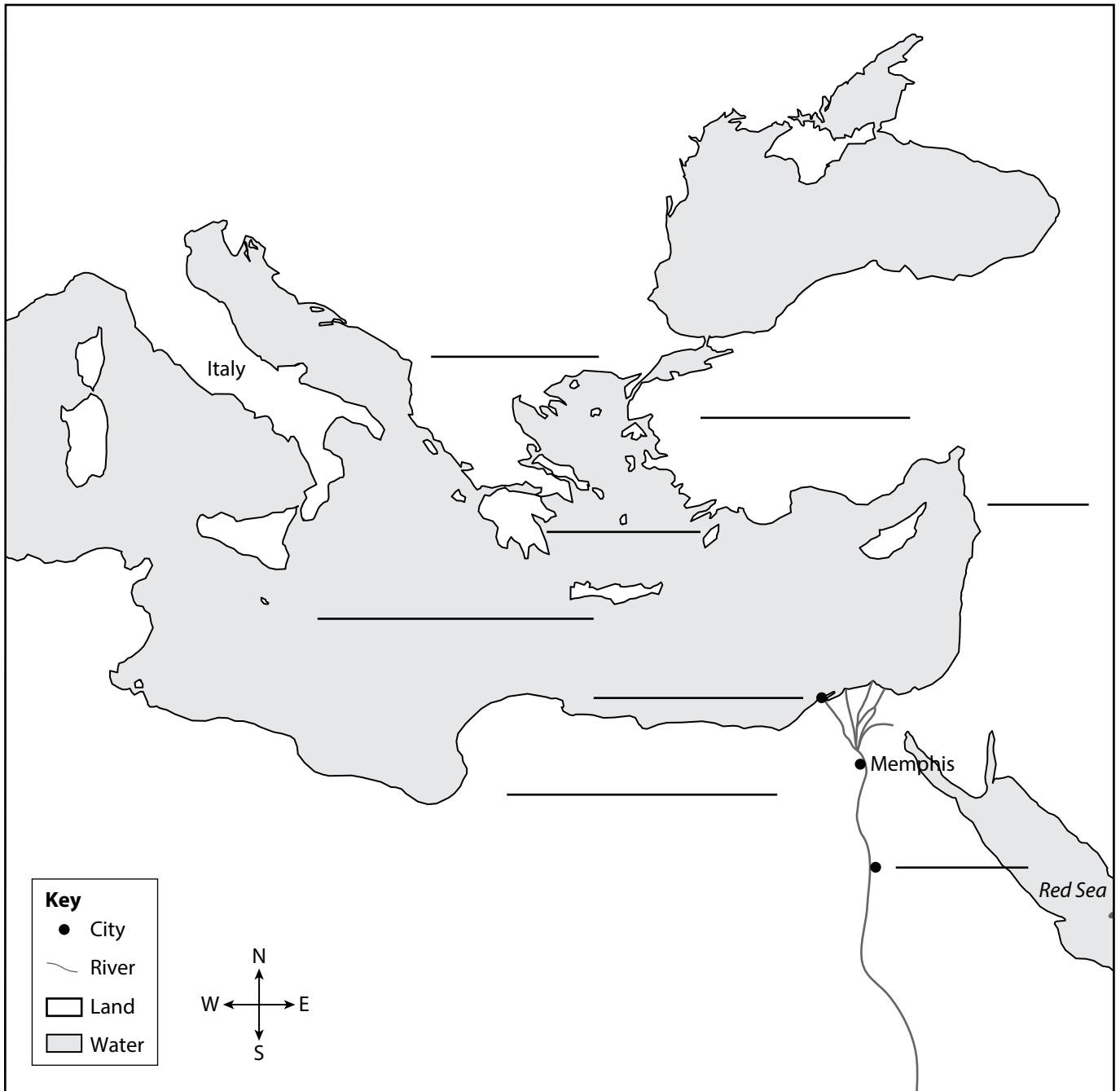

Name \_\_\_\_\_

Date \_\_\_\_\_

**Activity Page 6.1, Continued**

**Use with Chapter 6**

**Follow these directions to complete your map of Cleopatra’s Egypt.**

1. Label each of the following:  
Egypt      Mediterranean Sea      Syria  
Greece      Aegean Sea      Asia Minor
2. In the Mediterranean Sea, draw an arrow pointing toward Rome. Label the arrow “To Rome.”
3. Using blue, trace the Nile River. Label the Nile River.
4. Add the following cities to your map and label them:  
Alexandria      Thebes

**Use your completed map to answer these questions:**

5. If you traveled from Alexandria to Rome, in what direction would you be traveling?  
\_\_\_\_\_
6. If you were traveling by barge from Alexandria to Thebes, in what direction would you be traveling?  
\_\_\_\_\_
7. Why might the kings and queens of Egypt have used Alexandria as their capital instead of Memphis?  
\_\_\_\_\_  
\_\_\_\_\_
8. Caesar called for the Roman army in Syria to come to Alexandria. Would it have been easier for the army to reach Alexandria by land or by sea? Explain.  
\_\_\_\_\_  
\_\_\_\_\_  
\_\_\_\_\_

Name \_\_\_\_\_ Date \_\_\_\_\_

Fill in the diagram with details about Antony and Octavian. Facts that are true about both men should go in the middle of the diagram.

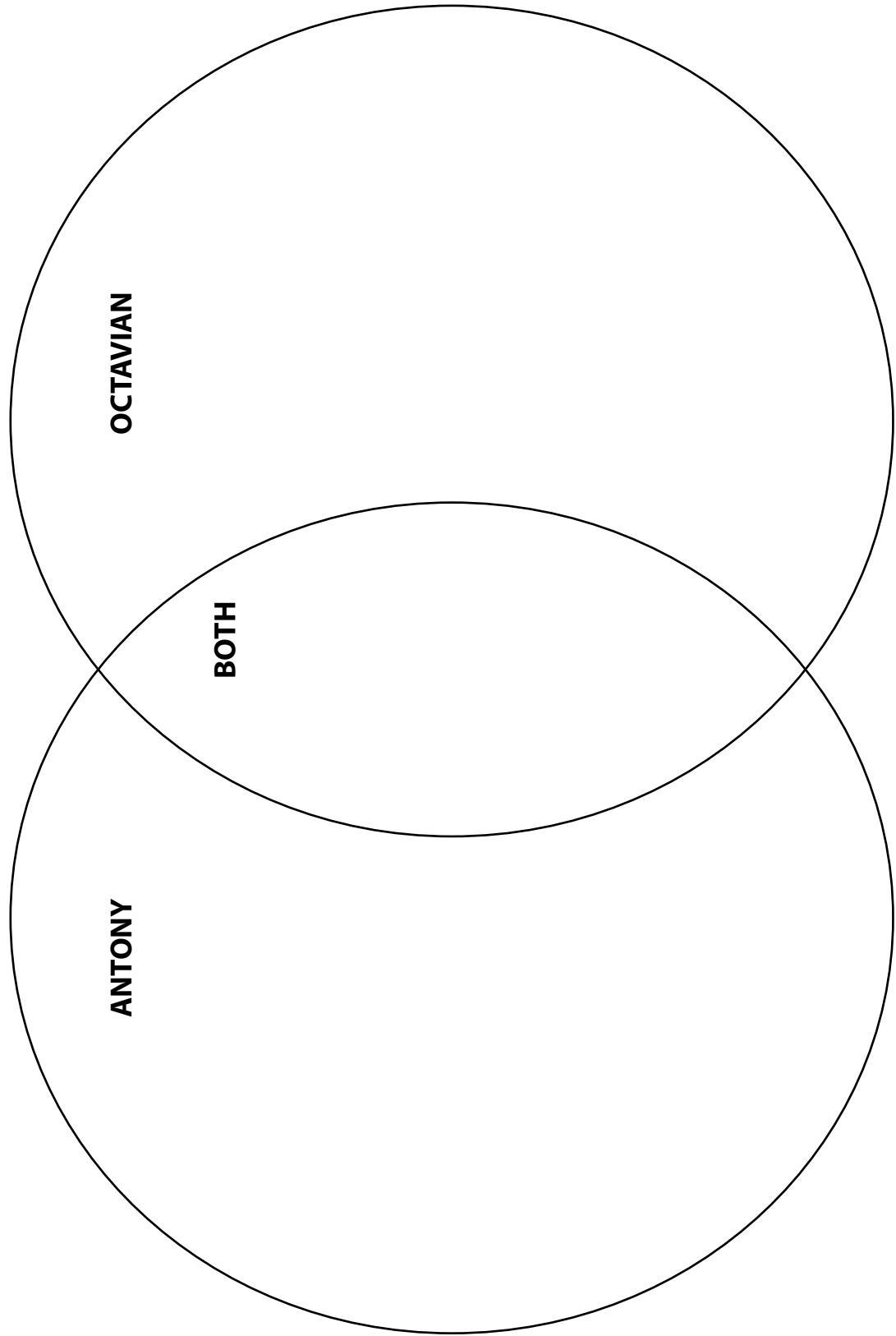

Name \_\_\_\_\_

Date \_\_\_\_\_

## Activity Page 7.2 Domain Vocabulary: Chapters 5–7

Use with Chapter 7

**Note:** This activity refers to content found in Chapters 5–7.

**Use the definition to identify each word. Write the word on the space provided, then find and circle the word in the puzzle. Words may read right, left, up, down, or diagonally. Circle each definition and word in the puzzle using a pencil or marker of the same color.**

### Word Choices

noble	foreigner	tax	republic	barge	Senate
dictator	assassinate	king	toga	province	governor
supplies	civil war	descendant	border	empire	

### Clues:

Patrician lawmaking body in Rome \_\_\_\_\_

A male ruler who comes to power by birth and who rules for life \_\_\_\_\_

A ruler who has total control over the country \_\_\_\_\_

A group of countries under the control of one government or one ruler \_\_\_\_\_

A kind of government where people elect representatives to rule for them \_\_\_\_\_

A country or area controlled by Rome \_\_\_\_\_

The leader of the government in a province \_\_\_\_\_

Money paid to the government \_\_\_\_\_

An imaginary line that marks the edge of a country or other piece of land \_\_\_\_\_

A war between people who live in the same country \_\_\_\_\_

A boat with a flat bottom, usually used for carrying goods \_\_\_\_\_

Someone who is related to a person or group of people who lived in the past \_\_\_\_\_

To kill a ruler or member of the government \_\_\_\_\_

A robe-like piece of clothing worn in ancient Rome \_\_\_\_\_

Someone from another country \_\_\_\_\_

Food and other goods that are needed for a certain purpose \_\_\_\_\_

Belonging to the highest social class \_\_\_\_\_

Name \_\_\_\_\_

Date \_\_\_\_\_

**Activity Page 7.2, Continued**

C P B F T M X J R G E D R W A  
I L O G O A I E P T W I A O G  
T M R R T R P T A R S C W Q O  
A V D J C U E N I E D T L B T  
F L E P B K I I I H H A I D X  
S M R L R S G L G J Z T V H L  
P C I U S O P N R N Z O I B V  
D C A A B P N S I W E R C G F  
W Q S A U R A R I K P R S E L  
Y S R S E N A T E E L B O N U  
A G X Q M F W H B V M E A X F  
E C N I V O R P C U O P O T Z  
M L F K E W V H M F H G I K U  
P P R U F Z C E M J R L Z R Z  
D E S C E N D A N T R I A A E

Name \_\_\_\_\_

Date \_\_\_\_\_

**Activity Page 8.1: Comparing Sources About Augustus**

**Use with Chapter 8**

**Complete the chart with details from each source.**

<b>Source 1—Student Reader Chapters 7 and 8:</b>	<b>Both Sources</b>	<b>Source 2—BBC’s “World History: Head of Emperor Augustus”:</b>

Name \_\_\_\_\_ Date \_\_\_\_\_

Study the map, and use it to answer the questions that follow.

Geography of the Roman Empire

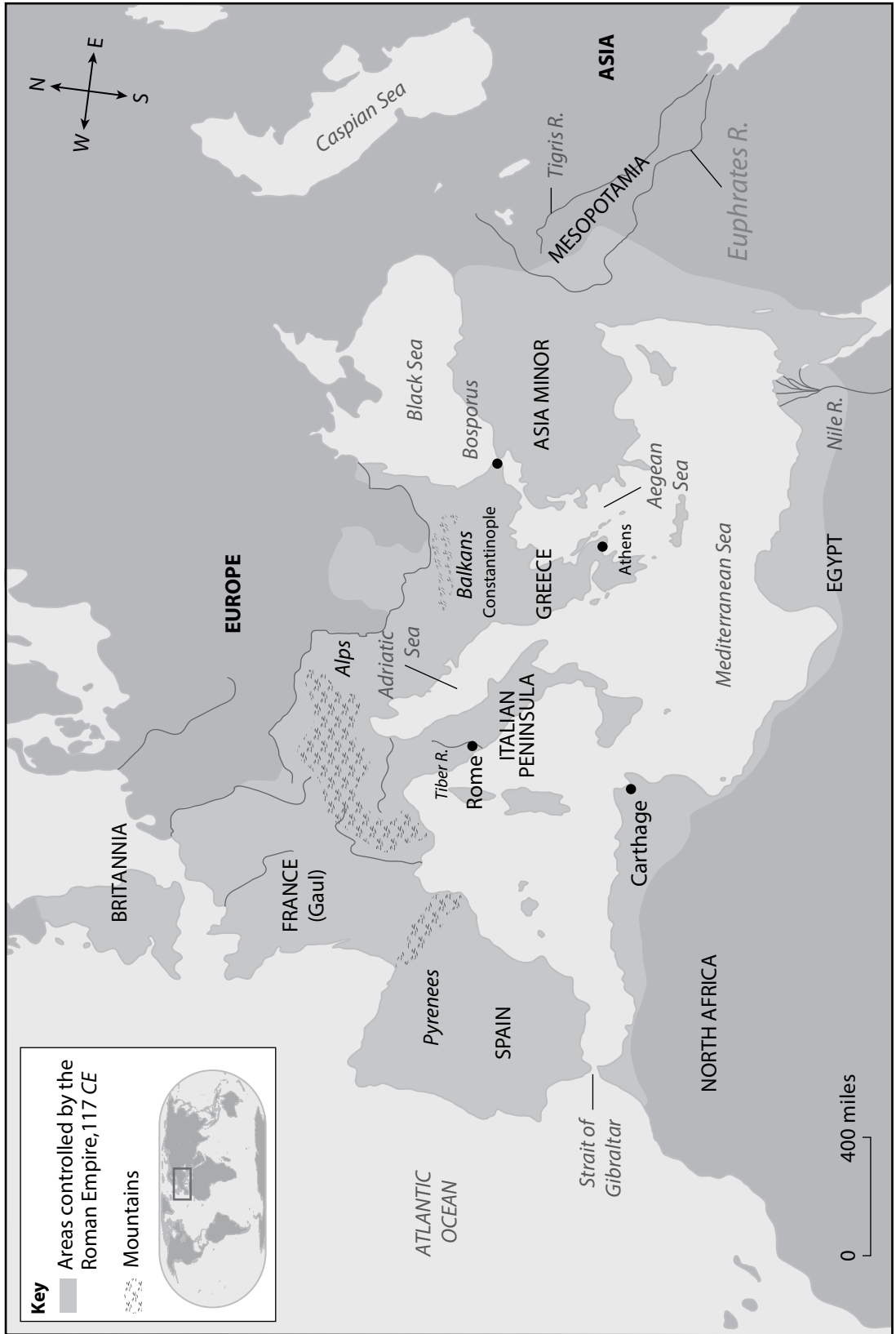



Name \_\_\_\_\_

Date \_\_\_\_\_

**Activity Page 9.1: Continued**

**Use with Chapter 9**

**Use the map to answer the following questions.**

1. Which Roman province was the farthest north?

\_\_\_\_\_

2. Which Roman province was the farthest east?

\_\_\_\_\_

3. Which Roman province was the farthest south?

\_\_\_\_\_

4. Which body of water forms the western boundary of the Roman Empire?

\_\_\_\_\_

5. Which three bodies of water surround Asia Minor?

\_\_\_\_\_

6. A Roman travels by land from Greece to Spain. On what continent is he or she traveling?  
What Roman provinces does he or she pass through?

\_\_\_\_\_

7. A Roman travels from Rome to Mesopotamia. What Roman provinces does he or she pass through?

\_\_\_\_\_

8. To sail from Athens to Constantinople, what bodies of water would you need to cross or pass through?

\_\_\_\_\_

Name \_\_\_\_\_

Date \_\_\_\_\_

**Activity Page 9.2: Then and Now**

**Use with Chapter 9**

**For each location in the Roman Empire listed, write the name it is called today. Some of the names will be the same. Some will be different. Use your Student Reader to find the names and map locations during the Roman Empire. Use an atlas with a modern map to find out the current names.**

<b>Then</b>	<b>Now</b>
1. Spain	_____
2. Carthage	_____
3. Gaul	_____
4. Britannia	_____
5. Rome	_____
6. Greece	_____
7. Constantinople	_____
8. Mesopotamia	_____
9. Egypt	_____

Name \_\_\_\_\_ Date \_\_\_\_\_

Label each diagram using words from the Word Bank. Use your Student Reader to help you.

- arch
- gravel
- large stones
- pillar
- stone finish
- road surface

A Roman Road

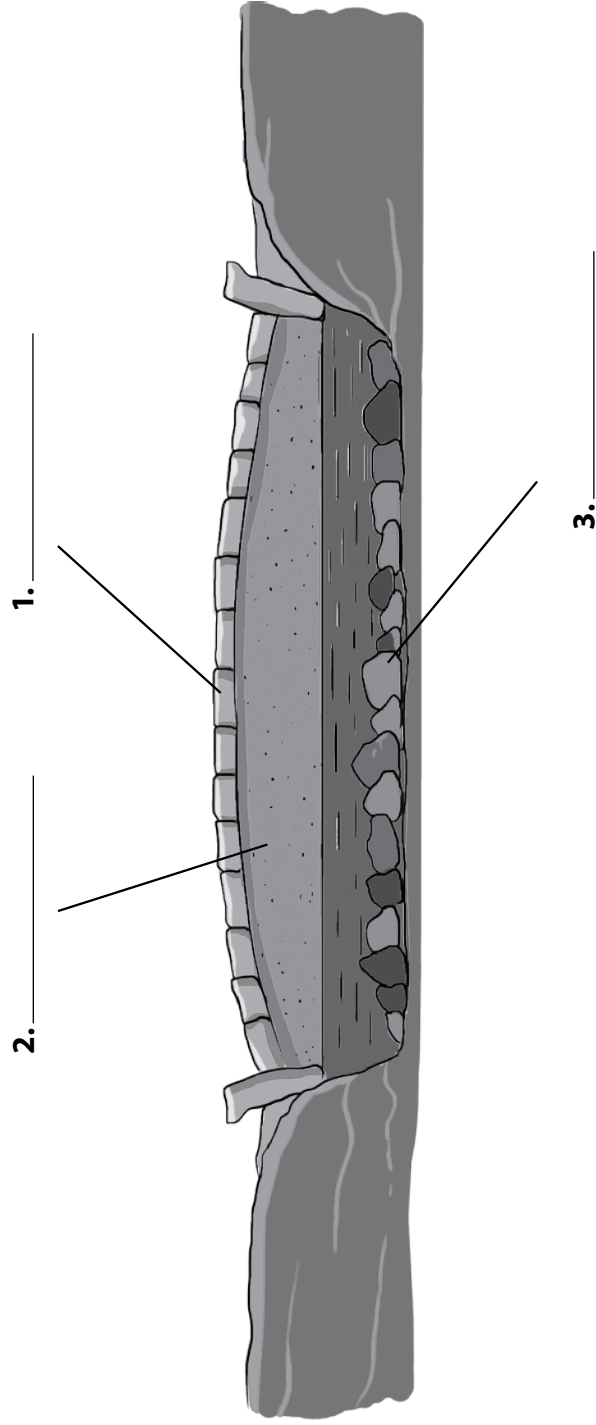

Name \_\_\_\_\_ Date \_\_\_\_\_

Label each diagram using words from the Word Bank. Use your Student Reader to help you.

- |              |              |              |        |
|--------------|--------------|--------------|--------|
| arch         | gravel       | large stones | pillar |
| stone finish | road surface |              |        |

A Roman Bridge

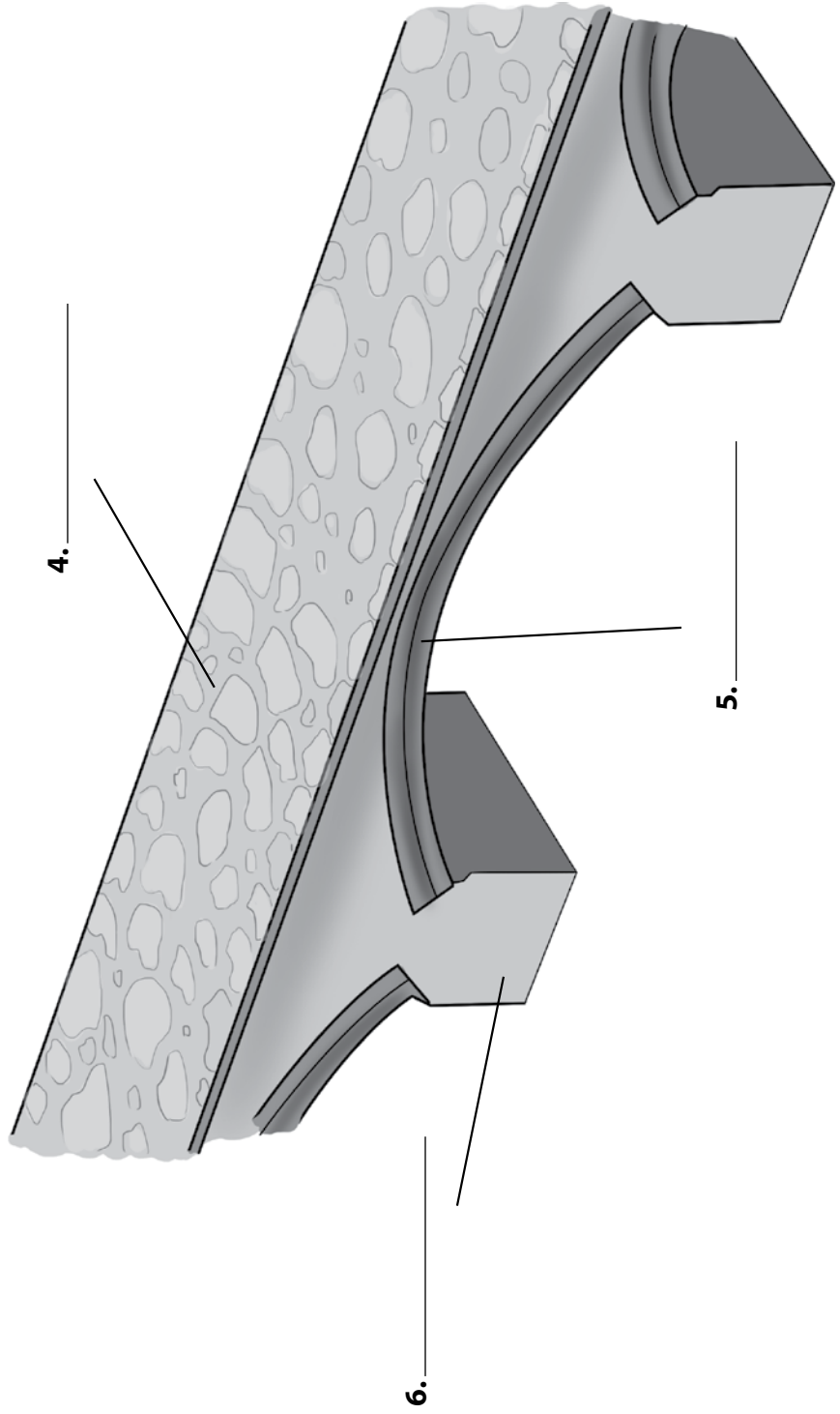

Name \_\_\_\_\_

Date \_\_\_\_\_

### Activity Page 11.1: The Pantheon

Use with Chapter 11

Label the diagram of the Pantheon using words from the Word Bank.

dome	pediment	oculus	pillar
ceiling panel	portico		

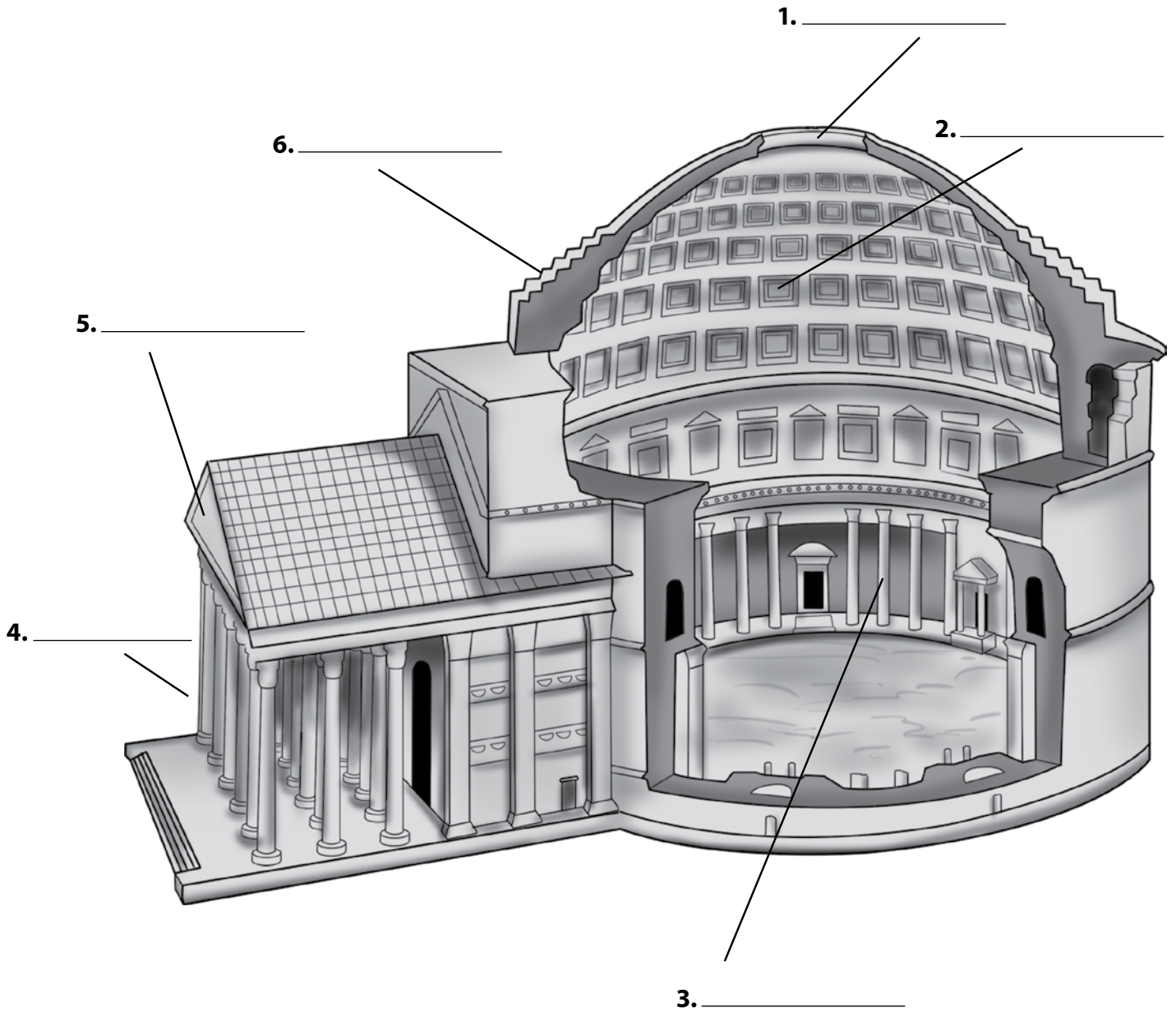

Name \_\_\_\_\_

Date \_\_\_\_\_

### Activity Page 11.2 Domain Vocabulary: Chapters 8–11

### Use with Chapter 11

**Note:** This activity refers to content found in Chapters 8–11.

**Match the terms from the column on the left with the description or definition on the right. Write the letter of the definition on the line.**

	<b>Terms</b>	<b>Definitions</b>
_____	<b>1.</b> aqueduct	<b>a)</b> home of the Senate and many Roman temples and markets
_____	<b>2.</b> arch	<b>b)</b> someone who gives money to writers and artists so that they can create works of art
_____	<b>3.</b> civil war	<b>c)</b> columns on buildings; also a straight structure that might support a bridge
_____	<b>4.</b> continent	<b>d)</b> carried water into the city of Rome
_____	<b>5.</b> emperor	<b>e)</b> a holy or sacred practice; how the Romans honored their gods
_____	<b>6.</b> Forum	<b>f)</b> Hannibal crossed one with elephants
_____	<b>7.</b> empire	<b>g)</b> the top layer; made of the smooth stones on a Roman road
_____	<b>8.</b> mountain range	<b>h)</b> the low area between two hills
_____	<b>9.</b> patron	<b>i)</b> a war between groups in the same country
_____	<b>10.</b> pillar	<b>j)</b> a narrow passage of water that separates larger bodies of water; there is one between the Mediterranean Sea and the Atlantic Ocean
_____	<b>11.</b> province	<b>k)</b> a group of countries or territories under the control of one ruler
_____	<b>12.</b> religious ceremony	<b>l)</b> areas conquered by another country; in the Roman Empire, examples include Gaul, Carthage, and Egypt
_____	<b>13.</b> scroll	<b>m)</b> a curved structure that might support a bridge
_____	<b>14.</b> strait	<b>n)</b> a person who rules an empire; Caesar Augustus was Rome's first one
_____	<b>15.</b> surface	<b>o)</b> a piece of parchment that could be written on and rolled up
_____	<b>16.</b> valley	<b>p)</b> Europe, Africa, or Asia are examples

Name \_\_\_\_\_

Date \_\_\_\_\_

**Activity Page 12.1: Androcles and the Lion**

**Use with Chapter 12**

1. Who was Androcles?

\_\_\_\_\_

2. How did Androcles first meet the lion?

\_\_\_\_\_

\_\_\_\_\_

3. How did Androcles become a gladiator?

\_\_\_\_\_

\_\_\_\_\_

4. What was supposed to happen when Androcles met the lion in the arena?

\_\_\_\_\_

\_\_\_\_\_

5. Why was the outcome of Androcles's fight with the lion a surprise?

\_\_\_\_\_

\_\_\_\_\_

Name \_\_\_\_\_

Date \_\_\_\_\_

**Activity Page 14.1 Domain Vocabulary: Chapters 12–14**

**Use with Chapter 14**

**Note:** This activity refers to content found in Chapters 12–14.

**Use the clues to complete the crossword puzzle using the words from the box.**

amphitheater	Earth's crust	pollution	archaeologist	emperor
preserve	arena	gladiator	religious belief	assassinate
goddess	ruins	chariot	kingdom	temple
Colosseum	mosaic	trade	debris	persecute
volcano				

**Across**

- 5. to buy and sell goods
- 7. a building that honors a god or goddess
- 13. what the Romans did to Christians
- 14. ruler of the Roman Empire
- 15. someone who fought another person or an animal for sport
- 16. remains of old buildings, such as those found in the Roman Forum
- 17. Mount Vesuvius is one
- 18. to keep or save
- 19. where gladiator fights were held in Rome
- 20. an expert who studies the ruins at Pompeii

**Down**

- 1. what the Roman senators did to Julius Caesar
- 2. a horse-pulled carriage used for Roman races
- 3. an open, outdoor building with rising seats
- 4. a country ruled by a king or queen
- 6. the rocky outer layer of the planet
- 8. something that makes land, water, or air unsafe
- 9. Vesta, Venus, or Juno
- 10. Pompeians decorated a floor with this
- 11. pieces of mountain spit into the air during an eruption
- 12. an idea about gods or faith
- 20. a stadium like the Colosseum



Name \_\_\_\_\_

Date \_\_\_\_\_

**Activity Page 14.1 Continued**

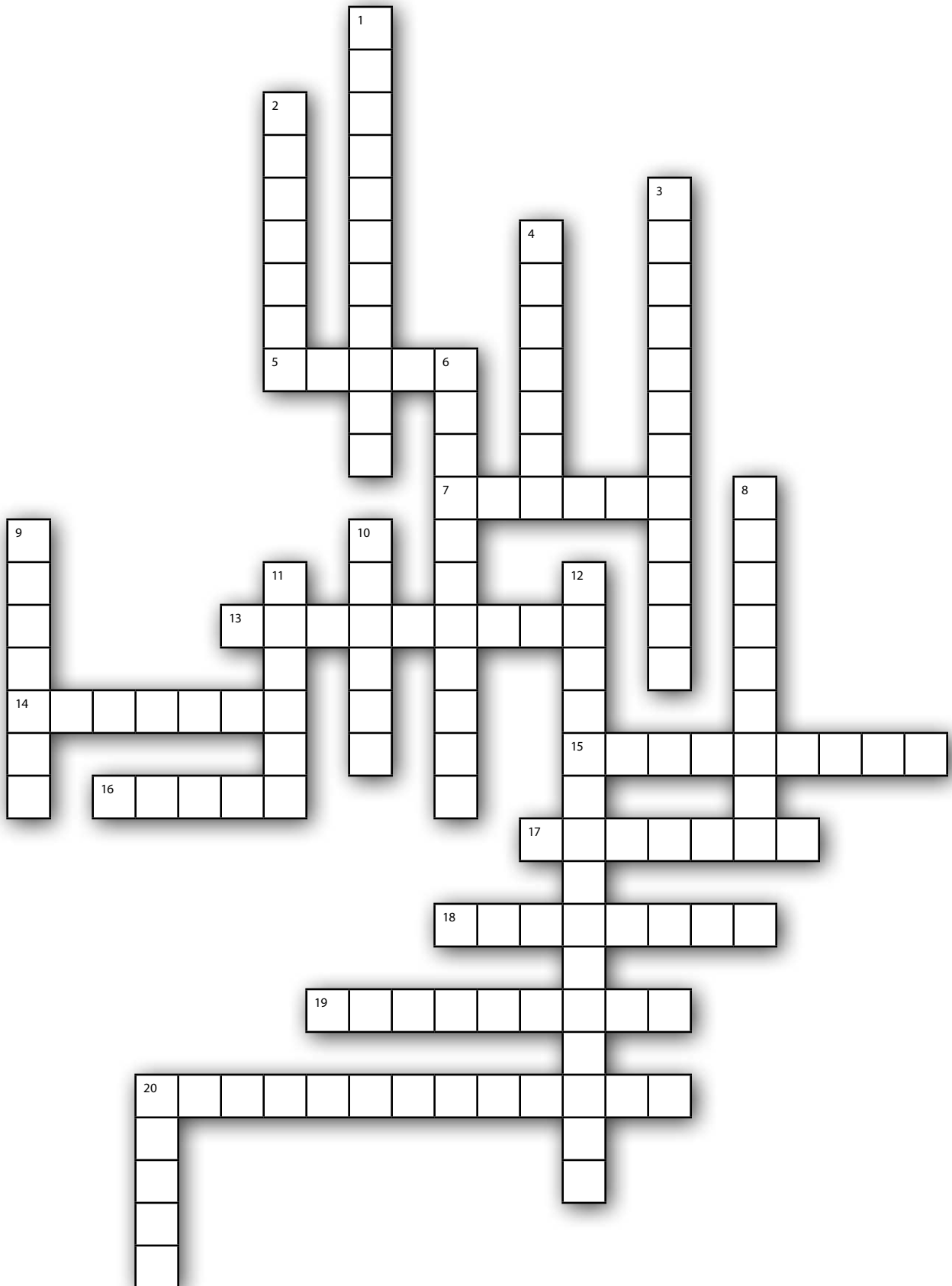

Name \_\_\_\_\_

Date \_\_\_\_\_

**Activity Page (16.1) Domain Vocabulary: Chapters 15–16**

**Use with Chapter 16**

**Note:** This activity refers to content found in Chapters 15–16.

**Use the words in the Word Bank to answer each riddle. You will not use all the words.**

assignment	city	collapse	corrupt	decline	emperor	empire		
holy	mosaic	persecute	pillage	practice	province	ruin	sack	strait

1. This is a place like Rome or Constantinople, where many people live and work.  
What is it? \_\_\_\_\_
2. This is a body of water, like the Bosphorus, that connects two large bodies of water.  
What is it? \_\_\_\_\_
3. This is art made of many small pieces of colorful stone or tile. There are many examples of it in Pompeii and Constantinople. What is it? \_\_\_\_\_
4. I am a ruler of many territories, such as Augustus or Constantine. What am I? \_\_\_\_\_
5. This is a piece of an old building or something else made by humans, such as those left by the Romans. What is it? \_\_\_\_\_
6. This is the act of growing weaker, like Rome did in its later years. What is it? \_\_\_\_\_
7. This is a task or job that is given to someone, such Luciano’s task of learning about Rome.  
What is it? \_\_\_\_\_
8. I live according to the teachings of religion or other set of ideas, such as what the Christians were allowed to do during Constantine’s rule. What am I doing? \_\_\_\_\_
9. I have stolen or destroyed things in a city that has been defeated by an army.  
What have I done? \_\_\_\_\_
10. The Western Empire did this when it failed or ended suddenly. What did it do? \_\_\_\_\_
11. I have used a government job for personal gain. What am I? \_\_\_\_\_
12. I steal things using force. What am I doing? \_\_\_\_\_

# Answer Key: Ancient Rome

## Unit Assessment

1. d 2. c 3. b 4. c 5. a 6. c 7. b 8. a 9. b 10. c 11. b  
12. a 13. d 14. a 15. c 16. c 17. d 18. b 19. c 20. c  
21. a 22. b 23. h 24. i 25. f 26. a 27. b 28. c 29. g  
30. e 31. j 32. d

## Activity Page

### World Geography (AP 1.2) (page 138)

1. South America, Africa, Asia
2. the Atlantic Ocean
3. The Americas are farther from Asia.
4. Atlantic Ocean, Arctic Ocean, Mediterranean Sea
5. the Mediterranean Sea

### Geography of the Mediterranean Region (AP 1.4) (page 140)

1. Europe, Asia, Africa
2. the Strait of Gibraltar, the Bosphorus
3. Italy
4. the Alps
5. south
6. about 350 miles (560 km)

### The Solar System (AP 2.1) (pages 142–143)

Planet	Roman God or Goddess It Is Named For	Reason for the Name
Mercury	Roman god of trade	It moves quickly across the sky.
Venus	Roman goddess of love and beauty	It shines brightly in the sky.
Mars	Roman god of war	It is the color of blood.
Jupiter	king of the Roman gods	It is the largest planet.

Saturn	Roman god of agriculture and time	It is the slowest to orbit the sun.
Neptune	Roman god of the sea	It is blue like the sea.

### The Roman Republic (AP 3.1) (page 144)

1. D., C. (Assembly, patricians)
2. A. (dictator)
3. C. (patrician)
4. F. (controlled)
5. B. (plebian)
6. E. (consul)

### Life in Rome (AP 3.2) (pages 145–146)

**PATRICIAN:** had larger homes, hired tutors for children, wore colors and stripes on clothing, or jewelry and hairstyles, that showed rank.

**PLEBIAN:** lived in crowded neighborhoods in buildings without plumbing; taught their children themselves; often held same job as parents had held; wore clothing styles that showed rank.

**BOTH:** spoke Latin, worshipped many gods; women did not participate in government; clothing for men included tunic and, often, toga on top; clothing for women included tunics.

### Domain Vocabulary: Chapters 1–4 (AP 4.1) (page 147)

1. capital
2. kings, republic, representatives
3. plebeians, Senate, patricians
4. goddess, temple, Forum
5. charcoal, sacred
6. consuls, dictator
7. barrier

## Cleopatra's Egypt (AP. 6.1) (pages 148–149)

5. northwest
6. south
7. Possible answer: Its location on the Mediterranean made travel and trade with other countries easier. Its location on the Nile made it easier for kings and queens to travel up and down their country as needed.
8. Possible answer: Traveling by sea would have been more direct and easier than traveling down and around the Mediterranean coast because they wouldn't have had to cross the desert or go through the Nile Delta.

## Antony and Octavian (AP 7.1) (page 150)

**ANTONY:** proud, brave, boastful, careless, claimed to be a descendant of Hercules, fell in love with Cleopatra, controlled the eastern part of the Roman Empire.

**OCTAVIAN:** thoughtful, proper in dress and manner, loyal to his family, Julius Caesar's adopted son, controlled the western part of the Roman Empire.

**BOTH:** won civil war against Caesar's murderers, shared control of Roman government.

## Domain Vocabulary: Chapters 5–7 (AP 7.2) (pages 151–152)

patrician lawmaking body in Rome: Senate

a male ruler who comes to power by birth and who rules for life: king

a ruler who has total control over the country: dictator

a group of countries under the control of one government or one ruler: empire

a kind of government where people elect representatives to rule for them: republic

a country or area controlled by Rome: province

the leader of the government in a province: governor

money paid to the government: tax

an imaginary line that marks the edge of a country or other piece of land: border

a war between people who live in the same country: civil war

a boat with a flat bottom, usually used for carrying goods: barge

someone who is related to a person or group of people who lived in the past: descendant

to kill a ruler or member of the government: assassinate

a robe-like piece of clothing worn in ancient Rome: toga

someone from another country: foreigner

food and other goods that are needed for a certain purpose: supplies

belonging to the highest social class: noble

## Comparing Sources About Augustus (AP 8.1) (page 153)

**SOURCE 1: STUDENT READER** Octavian was adopted by Julius Caesar; the Senate gave Octavian the title *Augustus*; Octavian refused the title *emperor*.

**SOURCE 2: HEAD OF EMPEROR AUGUSTUS** Born in 63 BCE; Died in 14 CE; Octavian was Caesar's heir; Julius Caesar was Octavian's great uncle; Octavian became emperor and took the name *Augustus*; Augustus was named a god after he died.

**BOTH SOURCES** Born Octavian; Octavian helped defeat the senators who killed Julius Caesar; Octavian defeated Antony and Cleopatra; Octavian improved Roman government and established law and order after years of civil war.

## Geography of the Roman Empire (AP 9.1) (pages 154–155)

1. Britannia
2. Mesopotamia
3. Egypt
4. Atlantic Ocean
5. Black Sea, Aegean Sea, Mediterranean Sea
6. Europe; Italy and Gaul
7. Greece and Asia Minor
8. Aegean Sea, the Bosphorus

## Then and Now (AP 9.2) (page 156)

1. Spain
2. Tunis
3. France



**Core Knowledge<sup>®</sup>**

**Series Editor-in-Chief**

E. D. Hirsch, Jr.

## Subject Matter Expert

Michael J. Carter, PhD, Department of Classics, Brock University

## Illustration and Photo Credits

ACME Imagery/Superstock: 9i, 102

Aureus (obverse) of Diocletian (AD 284–AD 305) cuirassed, wearing a laurel wreath (gold) Roman 4th c AD/Private Collection/Bridgeman Images: 115

Bas relief fragment portraying Cleopatra, Egyptian Ptolemaic Period (332–30 BC)/Musée du Louvre, Paris, France/De Agostini Picture Library/G. Dagli Orti/Bridgeman Images: 58

City walls, built during reign of Theodosius II (408–50) in AD 412–22, Byzantine / Istanbul, Turkey / Bridgeman Images: 9l

Coin depicting the god Janus, 753 BC–476 AD (metal), Roman/Bibliothèque Nationale, Paris, France/Bridgeman Images: 34

DeAgostini/SuperStock: 95

Emperor Constantine presenting his city to the Virgin and Child at Hagia Sophia (mosaic), Byzantine 10th c/Hagia Sophia, Istanbul, Turkey/Pictures from History/Bridgeman Images: 9k, 118

Exterior view of Hagia Sophia, built 532–37 AD/Istanbul, Turkey/Bildarchiv Steffens/Bridgeman Images: 119

Gold multiple (obverse) of the Emperor Augustus (31 BC–AD 14) wearing a laurel wreath. Minted c.7–6 BC/Roman/Museo Archeologico Nazionale, Naples, Italy/Bridgeman Images: 70

Heritage/Superstock: Cover C, 69

Ideal reconstruction of the Roman forum, the temple of Vesta, engraving by J. Hofbauer, 1911/De Agostini Picture Library/G. Dagli Orti/Bridgeman Images: 34

Jacob Wyatt: Cover A, Cover B, Cover D, i, iii, 9c, 9d, 9e, 9f, 9g, 9h, 9m, 47, 48a, 48b, 53, 54a, 54b, 58, 59, 63a, 63b, 64, 68, 110

James Steidl/Superstock: 79

Jed Henry: 9a, 24, 25a, 25b, 42, 79, 80, 86–87, 88

Kristin Kwan: 96a, 96b, 114a, 114b, 114c

LatitudeStock/Capture Ltd/Superstock: 80

Massimo Pizzotti/Age fotostock/Superstock: 103

Matthew Clark: 33

Peter Barritt/Robertharding/Superstock: 103

Pixtal/Superstock: 74

Radius/Superstock: 53

Robertharding/Superstock: 101, 113–114

Scott Hammond: 9j, 41a, 41b, 110

Shari Griffiths: 52–53

Statue of Caesar Augustus (63 BC–14 AD) from Velletri, 1st–2nd c. AD (marble), Roman/Louvre, Paris, France/Bridgeman Images: 109

Steve Vidler/Superstock: 74

Temple of Jupiter Capitolinus (Canina's Restoration) (engraving), English School 19th c/Private Collection/© Look and Learn/Bridgeman Images: 87

The Colosseum in Rome by Harry Green (b.1920)/Private Collection/© Look and Learn/Bridgeman Images: 94

The early city of Rome by Severino Baraldi (b.1930)/Private Collection/© Look and Learn/Bridgeman Images: 73

View of a Roman Villa, 1844 (oil on canvas) by Jean Achille Benouville (1815–91)/Musée d'Orsay, Paris, France/Bridgeman Images: 40

Westend61/Superstock: 69

Within this publication, the Core Knowledge Foundation has provided hyperlinks to independently owned and operated sites whose content we have determined to be of possible interest to you. At the time of publication, all links were valid and operational and the content accessed by the links provided additional information that supported the Core Knowledge curricular content and/or lessons. Please note that we do not monitor the links or the content on such sites on an ongoing basis and both may be constantly changing. We have no control over the links, the content or the policies, information-gathering or otherwise, of such linked sites.

By accessing these third-party sites and the content provided therein, you acknowledge and agree that the Core Knowledge Foundation makes no claims, promises, or guarantees about the accuracy, completeness, or adequacy of the content of such third-party websites, and expressly disclaims liability for errors and omissions in the either the links themselves, or the contents of such sites.

If you experience any difficulties when attempting to access one of the linked resources found within these materials, please contact the Core Knowledge Foundation:

Core Knowledge Foundation

801 E. High St.

Charlottesville, VA 22902

Email: [coreknow@coreknowledge.org](mailto:coreknow@coreknowledge.org)

# Core Knowledge Curriculum Series™

Series Editor-in-Chief

E. D. Hirsch, Jr.

## CKHG™

Core Knowledge **HISTORY AND GEOGRAPHY**

### Ancient Rome

*Core Knowledge Sequence* History and Geography 3

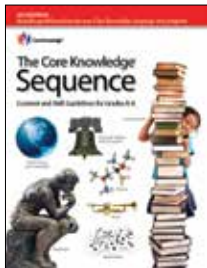

#### What is the *Core Knowledge Sequence*?

The *Core Knowledge Sequence* is a detailed guide to specific content and skills to be taught in grades K-8 in language arts, history, geography, mathematics, science, and the fine arts. In the domains of world and American history and geography, the *Core Knowledge Sequence* outlines topics that build chronologically or thematically grade by grade.

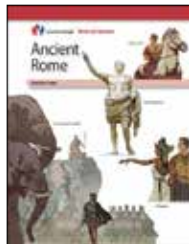

#### For which grade levels is this book intended?

In general, the content and presentation are appropriate for readers in the upper elementary grades. For teachers and schools following the *Core Knowledge Sequence*, this book is intended for Grade 3 and is part of a series of **Core Knowledge HISTORY AND GEOGRAPHY** units of study.

For a complete listing of resources in the **Core Knowledge HISTORY AND GEOGRAPHY** series, visit [www.coreknowledge.org](http://www.coreknowledge.org).

# CKHG™

## Core Knowledge **HISTORY AND GEOGRAPHY**

A comprehensive program in world and American history and geography, integrating topics in civics and the arts, exploring civilizations, cultures, and concepts specified in the *Core Knowledge Sequence* (content and skill guidelines for grades K-8).

### Core Knowledge **HISTORY AND GEOGRAPHY**

units at this level include:

1. **World Rivers**
2. **Ancient Rome**
3. **The Vikings**
4. **The Earliest Americans**
5. **Canada**
6. **Exploration of North America**
7. **The Thirteen Colonies**

[www.coreknowledge.org](http://www.coreknowledge.org)

**Core Knowledge Curriculum Series™**

**Series Editor-in-Chief**

E. D. Hirsch, Jr.